

SUN2000-(3KTL-10KTL)-M1

User Manual

Issue 19
Date 2024-09-06



Copyright © Huawei Digital Power Technologies Co., Ltd. 2024. All rights reserved.

No part of this document may be reproduced or transmitted in any form or by any means without prior written consent of Huawei Digital Power Technologies Co., Ltd.

Trademarks and Permissions



HUAWEI and other Huawei trademarks are the property of Huawei Technologies Co., Ltd.

All other trademarks and trade names mentioned in this document are the property of their respective holders.

Notice

The purchased products, services and features are stipulated by the contract made between Huawei Digital Power Technologies Co., Ltd. and the customer. All or part of the products, services and features described in this document may not be within the purchase scope or the usage scope. Unless otherwise specified in the contract, all statements, information, and recommendations in this document are provided "AS IS" without warranties, guarantees or representations of any kind, either express or implied. The information in this document is subject to change without notice. Every effort has been made in the preparation of this document to ensure accuracy of the contents, but all statements, information, and recommendations in this document do not constitute a warranty of any kind, express or implied.

Huawei Digital Power Technologies Co., Ltd.

Address: Huawei Digital Power Antuoshan Headquarters

Futian, Shenzhen 518043

People's Republic of China

Website: <https://e.huawei.com>

About This Document

Overview

This document describes the SUN2000-3KTL-M1, SUN2000-4KTL-M1, SUN2000-5KTL-M1, SUN2000-6KTL-M1, SUN2000-8KTL-M1, SUN2000-10KTL-BEM1 and SUN2000-10KTL-M1 (SUN2000 for short) in terms of their installation, electrical connections, commissioning, maintenance, and troubleshooting. Before installing and operating the SUN2000, ensure that you are familiar with the features, functions, and safety precautions provided in this document.

NOTE

The SUN2000-8KTL-M1, SUN2000-10KTL-BEM1 and SUN2000-10KTL-M1 are not applicable to Australia.



Intended Audience



This document is applicable to:

- Installers
- Users

Symbol Conventions

The symbols that may be found in this document are defined as follows:

Symbol	Description
	Indicates a hazard with a high level of risk which, if not avoided, will result in death or serious injury.
	Indicates a hazard with a medium level of risk which, if not avoided, could result in death or serious injury.
	Indicates a hazard with a low level of risk which, if not avoided, could result in minor or moderate injury.

Symbol	Description
	Indicates a potentially hazardous situation which, if not avoided, could result in equipment damage, data loss, performance deterioration, or unanticipated results. Notice is used to address practices not related to personal injury.
	Supplements the important information in the main text. NOTE is used to address information not related to personal injury, equipment damage, and environment deterioration.

Change History

Changes between document issues are cumulative. The latest document issue contains all the changes made in earlier issues.

Issue 19 (2024-09-06)

Add [7.2.4 DRM \(Australia AS4777\)](#).

Issue 18 (2024-06-24)

Delete Locating Insulation Resistance Faults.

Issue 17 (2024-01-12)

- Updated [5.2 Installation Preparation](#).
- Updated [5.8.2 Connecting the RS485 Communications Cable \(Smart Power Sensor\)](#).
- Updated [8.3 Troubleshooting](#).
- Updated [10.1 SUN2000 Technical Specifications](#).
- Updated [A Grid Code](#).

Issue 16 (2023-11-02)

Updated [5.4 Connecting the AC Output Power Cable](#).

Issue 15 (2023-09-30)

Updated [7.2.1.4 Peak Shaving](#).

Issue 14 (2023-09-06)

Updated [A Grid Code](#).

Issue 13 (2023-08-23)

Updated [D Rapid Shutdown](#).

Issue 12 (2023-07-30)

- Updated [About This Document](#).
- Updated [2.1 Product Introduction](#).
- Updated [5.2 Installation Preparation](#).
- Updated [10.1 SUN2000 Technical Specifications](#).

Issue 11 (2023-04-07)

- Updated [5.8.6 Connecting the NS Protection Signal Cable](#).
- Updated [A Grid Code](#).

Issue 10 (2023-02-07)

- Updated [2.1 Product Introduction](#).
- Updated [5.2 Installation Preparation](#).
- Updated [5.8.2 Connecting the RS485 Communications Cable \(Smart Power Sensor\)](#).
- Updated [5.8.6 Connecting the NS Protection Signal Cable](#).
- Updated [7.1.3 Creating a PV Plant and a User](#).
- Updated [7.1.4 \(Optional\) Setting the Physical Layout of the Smart PV Optimizers](#).
- Updated [7.2 Parameters Settings](#).

Issue 09 (2022-10-10)

- Updated [5.2 Installation Preparation](#).
- Updated [5.4 Connecting the AC Output Power Cable](#).

Issue 08 (2022-06-30)

- Updated [5.2 Installation Preparation](#).
- Add [7.2.1.4 Peak Shaving](#).
- Updated [10.1 SUN2000 Technical Specifications](#).
- Updated [A Grid Code](#).
- Add [E AI Energy Management Assistant \(EMMA\)](#).

Issue 07 (2022-03-04)

- Updated [5.8.2 Connecting the RS485 Communications Cable \(Smart Power Sensor\)](#).
- Updated [C Resetting Password](#).
- Updated [D Rapid Shutdown](#).

Issue 06 (2021-12-20)

- Updated [7.1.3 Creating a PV Plant and a User](#).
- Updated [7.2.1 Energy Control](#).
- Updated [10.1 SUN2000 Technical Specifications](#).

Issue 05 (2021-11-24)

Updated [10.1 SUN2000 Technical Specifications](#).

Issue 04 (2021-08-10)

- Updated [2.1 Product Introduction](#).
- Updated [5.5 Installing DC Input Power Cables](#).
- Updated [5.6 \(Optional\) Connecting Battery Cables](#).
- Updated [5.8 \(Optional\) Connecting the Signal Cable](#).
- Updated [7 Man-Machine Interaction](#).
- Updated [B Device Commissioning](#).

Issue 03 (2021-02-01)

- Updated [4.3.2 Space Requirements](#).
- Updated [5.8.2 Connecting the RS485 Communications Cable \(Smart Power Sensor\)](#).
- Updated [6.2 SUN2000 power-on](#).
- Updated [8.3 Troubleshooting](#).

Issue 02 (2020-11-20)

Updated [7.2.1.3 Battery Control](#).

Issue 01 (2020-09-30)

This issue is used for first office application (FOA).

Contents

About This Document.....	ii
1 Safety Information.....	1
1.1 Personal Safety.....	2
1.2 Electrical Safety.....	4
1.3 Environment Requirements.....	7
1.4 Mechanical Safety.....	9
2 Overview.....	13
2.1 Product Introduction.....	13
2.2 Appearance.....	16
2.3 Label Description.....	19
2.3.1 Enclosure Labels.....	19
2.3.2 Product Nameplate.....	21
2.4 Working Principles.....	21
2.4.1 Circuit Diagram.....	21
2.4.2 Working Modes.....	22
3 Storage.....	24
4 Installation.....	25
4.1 Checking Before Installation.....	25
4.2 Tools.....	26
4.3 Determining the Installation Position.....	27
4.3.1 Environment Requirements.....	27
4.3.2 Space Requirements.....	28
4.4 Moving the SUN2000.....	31
4.5 Installing the Mounting Bracket.....	31
4.5.1 Wall-mounted Installation.....	32
4.5.2 Support Mounting.....	34
5 Electrical Connections.....	38
5.1 Precautions.....	38
5.2 Installation Preparation.....	39
5.3 Connecting the PE cable.....	43
5.4 Connecting the AC Output Power Cable.....	45

5.5 Installing DC Input Power Cables.....	49
5.6 (Optional) Connecting Battery Cables.....	52
5.7 Installing the Smart Dongle.....	55
5.8 (Optional) Connecting the Signal Cable.....	56
5.8.1 Connecting the RS485 Communications Cable (Inverter Cascading).....	60
5.8.2 Connecting the RS485 Communications Cable (Smart Power Sensor).....	61
5.8.3 Connecting an RS485 Communications Cable (Between a Power Meter and a Battery).....	68
5.8.4 Connecting the Power Grid Scheduling Signal Cable.....	69
5.8.5 Connecting a Signal Cable to the Smart Backup Box.....	70
5.8.6 Connecting the NS Protection Signal Cable.....	72
6 Commissioning.....	75
6.1 Checking Before Power-On.....	75
6.2 SUN2000 power-on.....	76
7 Man-Machine Interaction.....	83
7.1 App Commissioning.....	83
7.1.1 Downloading the FusionSolar App.....	83
7.1.2 (Optional) Registering an Installer Account.....	84
7.1.3 Creating a PV Plant and a User.....	85
7.1.4 (Optional) Setting the Physical Layout of the Smart PV Optimizers.....	85
7.1.5 Detecting Optimizer Disconnection.....	88
7.2 Parameters Settings.....	88
7.2.1 Energy Control.....	89
7.2.1.1 Grid-tied Point Control.....	89
7.2.1.2 Apparent Power Control on the Inverter Output Side.....	92
7.2.1.3 Battery Control.....	93
7.2.1.4 Peak Shaving.....	95
7.2.2 AFCI.....	97
7.2.3 IPS Check (for Italy CEI0-21 Grid Code Only).....	99
7.2.4 DRM (Australia AS4777).....	101
7.3 SmartLogger Networking Scenario.....	102
8 Maintenance.....	103
8.1 SUN2000 Power-Off.....	103
8.2 Routine Maintenance.....	104
8.3 Troubleshooting.....	105
9 Handling the Inverter.....	106
9.1 Removing the SUN2000.....	106
9.2 Packing the SUN2000.....	106
9.3 Disposing of the SUN2000.....	106
10 Technical Specifications.....	107
10.1 SUN2000 Technical Specifications.....	107

10.2 Optimizer Technical Specifications.....	116
A Grid Code.....	119
B Device Commissioning.....	122
C Resetting Password.....	125
D Rapid Shutdown.....	128
E AI Energy Management Assistant (EMMA).....	129
F Acronyms and Abbreviations.....	130

1 Safety Information

Statement

Before transporting, storing, installing, operating, using, and/or maintaining the equipment, read this document, strictly follow the instructions provided herein, and follow all the safety instructions on the equipment and in this document. In this document, "equipment" refers to the products, software, components, spare parts, and/or services related to this document; "the Company" refers to the manufacturer (producer), seller, and/or service provider of the equipment; "you" refers to the entity that transports, stores, installs, operates, uses, and/or maintains the equipment.

The **Danger, Warning, Caution, and Notice** statements described in this document do not cover all the safety precautions. You also need to comply with relevant international, national, or regional standards and industry practices. **The Company shall not be liable for any consequences that may arise due to violations of safety requirements or safety standards concerning the design, production, and usage of the equipment.**

The equipment shall be used in an environment that meets the design specifications. Otherwise, the equipment may be faulty, malfunctioning, or damaged, which is not covered under the warranty. The Company shall not be liable for any property loss, personal injury, or even death caused thereby.

Comply with applicable laws, regulations, standards, and specifications during transportation, storage, installation, operation, use, and maintenance.

Do not perform reverse engineering, decompilation, disassembly, adaptation, implantation, or other derivative operations on the equipment software. Do not study the internal implementation logic of the equipment, obtain the source code of the equipment software, violate intellectual property rights, or disclose any of the performance test results of the equipment software.

The Company shall not be liable for any of the following circumstances or their consequences:

- The equipment is damaged due to force majeure such as earthquakes, floods, volcanic eruptions, debris flows, lightning strikes, fires, wars, armed conflicts, typhoons, hurricanes, tornadoes, and other extreme weather conditions.
- The equipment is operated beyond the conditions specified in this document.

- The equipment is installed or used in environments that do not comply with international, national, or regional standards.
- The equipment is installed or used by unqualified personnel.
- You fail to follow the operation instructions and safety precautions on the product and in the document.
- You remove or modify the product or modify the software code without authorization.
- You or a third party authorized by you cause the equipment damage during transportation.
- The equipment is damaged due to storage conditions that do not meet the requirements specified in the product document.
- You fail to prepare materials and tools that comply with local laws, regulations, and related standards.
- The equipment is damaged due to your or a third party's negligence, intentional breach, gross negligence, or improper operations, or other reasons not related to the Company.

[1.1 Personal Safety](#)

[1.2 Electrical Safety](#)

[1.3 Environment Requirements](#)

[1.4 Mechanical Safety](#)

1.1 Personal Safety

 **DANGER**

Ensure that power is off during installation. Do not install or remove a cable with power on. Transient contact between the core of the cable and the conductor will generate electric arcs or sparks, which may cause a fire or personal injury.

 **DANGER**

Non-standard and improper operations on the energized equipment may cause fire, electric shocks, or explosion, resulting in property damage, personal injury, or even death.

 **DANGER**

Before operations, remove conductive objects such as watches, bracelets, bangles, rings, and necklaces to prevent electric shocks.

⚠ DANGER

During operations, use dedicated insulated tools to prevent electric shocks or short circuits. The dielectric withstanding voltage level must comply with local laws, regulations, standards, and specifications.

⚠ WARNING

During operations, wear personal protective equipment such as protective clothing, insulated shoes, goggles, safety helmets, and insulated gloves.

Figure 1-1 Personal protective equipment



General Requirements

- Do not stop protective devices. Pay attention to the warnings, cautions, and related precautionary measures in this document and on the equipment.
- If there is a likelihood of personal injury or equipment damage during operations, immediately stop, report the case to the supervisor, and take feasible protective measures.
- Do not power on the equipment before it is installed or confirmed by professionals.
- Do not touch the power supply equipment directly or with conductors such as damp objects. Before touching any conductor surface or terminal, measure the voltage at the contact point to ensure that there is no risk of electric shock.
- Do not touch operating equipment because the enclosure is hot.
- Do not touch a running fan with your hands, components, screws, tools, or boards. Otherwise, personal injury or equipment damage may occur.
- In the case of a fire, immediately leave the building or the equipment area and activate the fire alarm or call emergency services. Do not enter the affected building or equipment area under any circumstances.

Personnel Requirements

- Only professionals and trained personnel are allowed to operate the equipment.
 - Professionals: personnel who are familiar with the working principles and structure of the equipment, trained or experienced in equipment operations and are clear of the sources and degree of various potential hazards in equipment installation, operation, maintenance
 - Trained personnel: personnel who are trained in technology and safety, have required experience, are aware of possible hazards on themselves in certain operations, and are able to take protective measures to minimize the hazards on themselves and other people
- Personnel who plan to install or maintain the equipment must receive adequate training, be able to correctly perform all operations, and understand all necessary safety precautions and local relevant standards.
- Only qualified professionals or trained personnel are allowed to install, operate, and maintain the equipment.
- Only qualified professionals are allowed to remove safety facilities and inspect the equipment.
- Personnel who will perform special tasks such as electrical operations, working at heights, and operations of special equipment must possess the required local qualifications.
- Only authorized professionals are allowed to replace the equipment or components (including software).
- Only personnel who need to work on the equipment are allowed to access the equipment.

1.2 Electrical Safety

 **DANGER**

Before connecting cables, ensure that the equipment is intact. Otherwise, electric shocks or fire may occur.

 **DANGER**

Non-standard and improper operations may result in fire or electric shocks.

 **DANGER**

Prevent foreign matter from entering the equipment during operations. Otherwise, equipment short-circuits or damage, load power derating, power failure, or personal injury may occur.

⚠ WARNING

For the equipment that needs to be grounded, install the ground cable first when installing the equipment and remove the ground cable last when removing the equipment.

⚠ WARNING

During the installation of PV strings and the inverter, the positive or negative terminals of PV strings may be short-circuited to ground if the power cables are not properly installed or routed. In this case, an AC or DC short circuit may occur and damage the inverter. The resulting device damage is not covered under any warranty.

⚠ CAUTION

Do not route cables near the air intake or exhaust vents of the equipment.

General Requirements

- Follow the procedures described in the document for installation, operation, and maintenance. Do not reconstruct or alter the equipment, add components, or change the installation sequence without permission.
- Obtain approval from the national or local electric utility company before connecting the equipment to the grid.
- Observe the power plant safety regulations, such as the operation and work ticket mechanisms.
- Install temporary fences or warning ropes and hang "No Entry" signs around the operation area to keep unauthorized personnel away from the area.
- Before installing or removing power cables, turn off the switches of the equipment and its upstream and downstream switches.
- Before performing operations on the equipment, check that all tools meet the requirements and record the tools. After the operations are complete, collect all of the tools to prevent them from being left inside the equipment.
- Before installing power cables, check that cable labels are correct and cable terminals are insulated.
- When installing the equipment, use a torque tool of a proper measurement range to tighten the screws. When using a wrench to tighten the screws, ensure that the wrench does not tilt and the torque error does not exceed 10% of the specified value.
- Ensure that bolts are tightened with a torque tool and marked in red and blue after double-check. Installation personnel mark tightened bolts in blue. Quality inspection personnel confirm that the bolts are tightened and then mark them in red. (The marks must cross the edges of the bolts.)

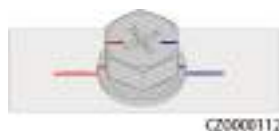

- If the equipment has multiple inputs, disconnect all the inputs before operating the equipment.
- Before maintaining a downstream electrical or power distribution device, turn off the output switch on the power supply equipment.
- During equipment maintenance, attach "Do not switch on" labels near the upstream and downstream switches or circuit breakers as well as warning signs to prevent accidental connection. The equipment can be powered on only after troubleshooting is complete.
- Do not open equipment panels.
- Check equipment connections periodically, ensuring that all screws are securely tightened.
- Only qualified professionals can replace a damaged cable.
- Do not scrawl, damage, or block any labels or nameplates on the equipment. Promptly replace labels that have worn out.
- Do not use solvents such as water, alcohol, or oil to clean electrical components inside or outside of the equipment.

Grounding

- Ensure that the grounding impedance of the equipment complies with local electrical standards.
- Ensure that the equipment is connected permanently to the protective ground. Before operating the equipment, check its electrical connection to ensure that it is reliably grounded.
- Do not work on the equipment in the absence of a properly installed ground conductor.
- Do not damage the ground conductor.

Cabling Requirements

- When selecting, installing, and routing cables, follow local safety regulations and rules.
- When routing power cables, ensure that there is no coiling or twisting. Do not join or weld power cables. If necessary, use a longer cable.
- Ensure that all cables are properly connected and insulated, and meet specifications.
- Ensure that the slots and holes for routing cables are free from sharp edges, and that the positions where cables are routed through pipes or cable holes are equipped with cushion materials to prevent the cables from being damaged by sharp edges or burrs.
- Ensure that cables of the same type are bound together neatly and straight and that the cable sheath is intact. When routing cables of different types, ensure that they are away from each other without entanglement and overlapping.
- Secure buried cables using cable supports and cable clips. Ensure that the cables in the backfill area are in close contact with the ground to prevent cable deformation or damage during backfilling.
- If the external conditions (such as the cable layout or ambient temperature) change, verify the cable usage in accordance with the IEC-60364-5-52 or local

laws and regulations. For example, check that the current-carrying capacity meets requirements.

- When routing cables, reserve at least 30 mm clearance between the cables and heat-generating components or areas. This prevents deterioration or damage to the cable insulation layer.

1.3 Environment Requirements

DANGER

Do not expose the equipment to flammable or explosive gas or smoke. Do not perform any operation on the equipment in such environments.

DANGER

Do not store any flammable or explosive materials in the equipment area.

DANGER

Do not place the equipment near heat sources or fire sources, such as smoke, candles, heaters, or other heating devices. Overheat may damage the equipment or cause a fire.

WARNING

Install the equipment in an area far away from liquids. Do not install it under areas prone to condensation, such as under water pipes and air exhaust vents, or areas prone to water leakage, such as air conditioner vents, ventilation vents, or feeder windows of the equipment room. Ensure that no liquid enters the equipment to prevent faults or short circuits.

WARNING

To prevent damage or fire due to high temperature, ensure that the ventilation vents or heat dissipation systems are not obstructed or covered by other objects while the equipment is running.

General Requirements

- Store the equipment according to the storage requirements. Equipment damage caused by unqualified storage conditions is not covered under the warranty.

- Keep the installation and operating environments of the equipment within the allowed ranges. Otherwise, its performance and safety will be compromised.
- The operating temperature range provided in the equipment's technical specifications refers to the ambient temperatures in equipment's installation environment.
- Do not install, use, or operate outdoor equipment and cables (including but not limited to moving equipment, operating equipment and cables, inserting connectors to or removing connectors from signal ports connected to outdoor facilities, working at heights, performing outdoor installation, and opening doors) in harsh weather conditions such as lightning, rain, snow, and level 6 or stronger wind.
- Do not install the equipment in an environment with dust, smoke, volatile or corrosive gases, infrared and other radiations, organic solvents, or salty air.
- Do not install the equipment in an environment with conductive metal or magnetic dust.
- Do not install the equipment in an area conducive to the growth of microorganisms such as fungus or mildew.
- Do not install the equipment in an area with strong vibration, noise, or electromagnetic interference.
- Ensure that the site complies with local laws, regulations, and related standards.
- Ensure that the ground in the installation environment is solid, free from spongy or soft soil, and not prone to subsidence. The site must not be located in a low-lying land prone to water or snow accumulation, and the horizontal level of the site must be above the highest water level of that area in history.
- Do not install the equipment in a position that may be submerged in water.
- If the equipment is installed in a place with abundant vegetation, in addition to routine weeding, harden the ground underneath the equipment using cement or gravel (the area shall be greater than or equal to 3 m x 2.5 m).
- Do not install the equipment outdoors in salt-affected areas because it may be corroded. A salt-affected area refers to the region within 500 m of the coast or prone to sea breeze. Regions prone to sea breeze vary with weather conditions (such as typhoons and monsoons) or terrains (such as dams and hills).
- Before installation, operation, and maintenance, clean up any water, ice, snow, or other foreign objects on the top of the equipment.
- When installing the equipment, ensure that the installation surface is solid enough to bear the weight of the equipment.
- After installing the equipment, remove the packing materials such as cartons, foam, plastics, and cable ties from the equipment area.

1.4 Mechanical Safety

WARNING

Ensure that all necessary tools are ready and inspected by a professional organization. Do not use tools that have signs of scratches or fail to pass the inspection or whose inspection validity period has expired. Ensure that the tools are secure and not overloaded.

WARNING

Do not drill holes into the equipment. Doing so may affect the sealing performance and electromagnetic containment of the equipment and damage components or cables inside. Metal shavings from drilling may short-circuit boards inside the equipment.

General Requirements

- Repaint any paint scratches caused during equipment transportation or installation in a timely manner. Equipment with scratches must not be exposed for an extended period of time.
- Do not perform operations such as arc welding and cutting on the equipment without evaluation by the Company.
- Do not install other devices on the top of the equipment without evaluation by the Company.
- When performing operations over the top of the equipment, take measures to protect the equipment against damage.
- Use correct tools and operate them in the correct way.

Moving Heavy Objects

- Be cautious to prevent injury when moving heavy objects.

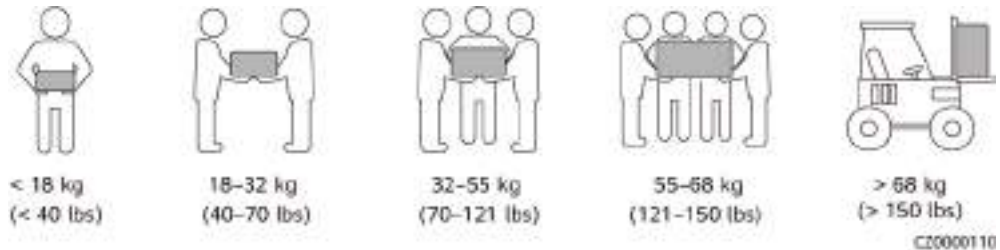

- If multiple persons need to move a heavy object together, determine the manpower and work division with consideration of height and other conditions to ensure that the weight is equally distributed.
- If two persons or more move a heavy object together, ensure that the object is lifted and landed simultaneously and moved at a uniform pace under the supervision of one person.

- Wear personal protective gears such as protective gloves and shoes when manually moving the equipment.
- To move an object by hand, approach to the object, squat down, and then lift the object gently and stably by the force of the legs instead of your back. Do not lift it suddenly or turn your body around.
- Do not quickly lift a heavy object above your waist. Place the object on a workbench that is half-waist high or any other appropriate place, adjust the positions of your palms, and then lift it.
- Move a heavy object stably with balanced force at an even and low speed. Put down the object stably and slowly to prevent any collision or drop from scratching the surface of the equipment or damaging the components and cables.
- When moving a heavy object, be aware of the workbench, slope, staircase, and slippery places. When moving a heavy object through a door, ensure that the door is wide enough to move the object and avoid bumping or injury.
- When transferring a heavy object, move your feet instead of turning your waist around. When lifting and transferring a heavy object, ensure that your feet point to the target direction of movement.
- When transporting the equipment using a pallet truck or forklift, ensure that the tynes are properly positioned so that the equipment does not topple. Before moving the equipment, secure it to the pallet truck or forklift using ropes. When moving the equipment, assign dedicated personnel to take care of it.
- Choose sea, roads in good conditions, or airplanes for transportation. Do not transport the equipment by railway. Avoid tilt or jolt during transportation.

Using Ladders

- Use wooden or insulated ladders when you need to perform live-line working at heights.
- Platform ladders with protective rails are preferred. Single ladders are not recommended.
- Before using a ladder, check that it is intact and confirm its load bearing capacity. Do not overload it.
- Ensure that the ladder is securely positioned and held firm.



- When climbing up the ladder, keep your body stable and your center of gravity between the side rails, and do not overreach to the sides.

- When a step ladder is used, ensure that the pull ropes are secured.
- If a single ladder is used, the recommended angle for the ladder against the floor is 75 degrees, as shown in the following figure. A square can be used to measure the angle.

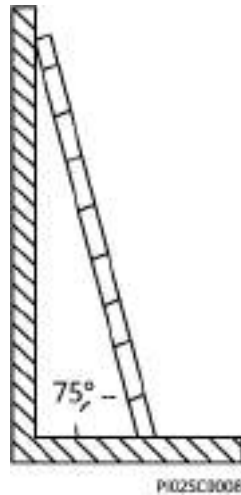

- If a single ladder is used, ensure that the wider end of the ladder is at the bottom, and take protective measures to prevent the ladder from sliding.
- If a single ladder is used, do not climb higher than the fourth rung of the ladder from the top.
- If you use a single ladder to climb up to a platform, ensure that the ladder is at least 1 m higher than the platform.

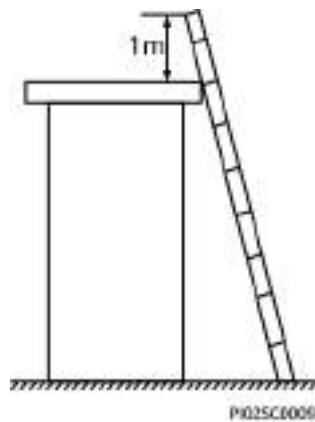

Hoisting

- Only trained and qualified personnel are allowed to perform hoisting operations.
- Install temporary warning signs or fences to isolate the hoisting area.
- Ensure that the foundation where hoisting is performed on meets the load-bearing requirements.
- Before hoisting objects, ensure that hoisting tools are firmly secured onto a fixed object or wall that meets the load-bearing requirements.
- During hoisting, do not stand or walk under the crane or the hoisted objects.
- Do not drag steel ropes and hoisting tools or bump the hoisted objects against hard objects during hoisting.

- Ensure that the angle between two hoisting ropes is no more than 90 degrees, as shown in the following figure.

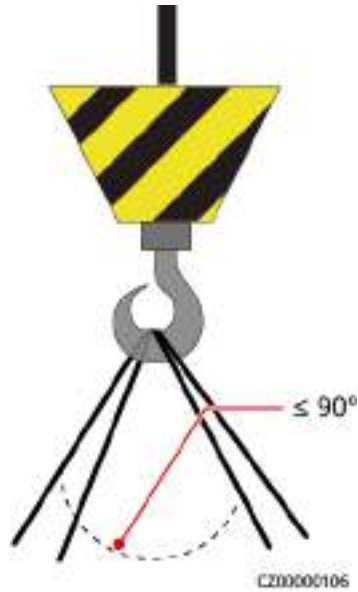

Drilling Holes

- Obtain consent from the customer and contractor before drilling holes.
- Wear protective equipment such as safety goggles and protective gloves when drilling holes.
- To avoid short circuits or other risks, do not drill holes into buried pipes or cables.
- When drilling holes, protect the equipment from shavings. After drilling, clean up any shavings.

2 Overview

- [2.1 Product Introduction](#)
- [2.2 Appearance](#)
- [2.3 Label Description](#)
- [2.4 Working Principles](#)

2.1 Product Introduction

Functions

The SUN2000 inverter is a three-phase grid-tied PV string inverter that converts the DC power generated by PV strings into AC power and feeds the power into the power grid.

Model

This document covers the following SUN2000 models:

- SUN2000-3KTL-M1
- SUN2000-4KTL-M1
- SUN2000-5KTL-M1
- SUN2000-6KTL-M1
- SUN2000-8KTL-M1
- SUN2000-10KTL-M1
- SUN2000-10KTL-BEM1

NOTE

The SUN2000-8KTL-M1, SUN2000-10KTL-BEM1 and SUN2000-10KTL-M1 are not applicable to Australia.

Figure 2-1 Model description (using SUN2000-5KTL-M1 as an example)

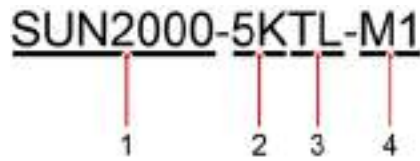

Table 2-1 Model description

Identifier	Description	Value
1	Product family name	SUN2000: three-phase grid-tied PV string inverter
2	Power class	<ul style="list-style-type: none"> • 3K: rated power of 3 kW • 4K: rated power of 4 kW • 5K: rated power of 5 kW • 6K: rated power of 6 kW • 8K: rated power of 8 kW • 10K: rated power of 10 kW
3	Topology	TL: transformerless
4	Product code	M1: product series with an input voltage level of 1100 V DC

Networking Application

The SUN2000 applies to residential rooftop grid-tied systems and small-sized ground PV plant grid-tied systems. Typically, a grid-tied system consists of PV strings, grid-tied inverters, AC switches, and power distribution units.

Figure 2-2 Networking application (dashed boxes indicate optional components)

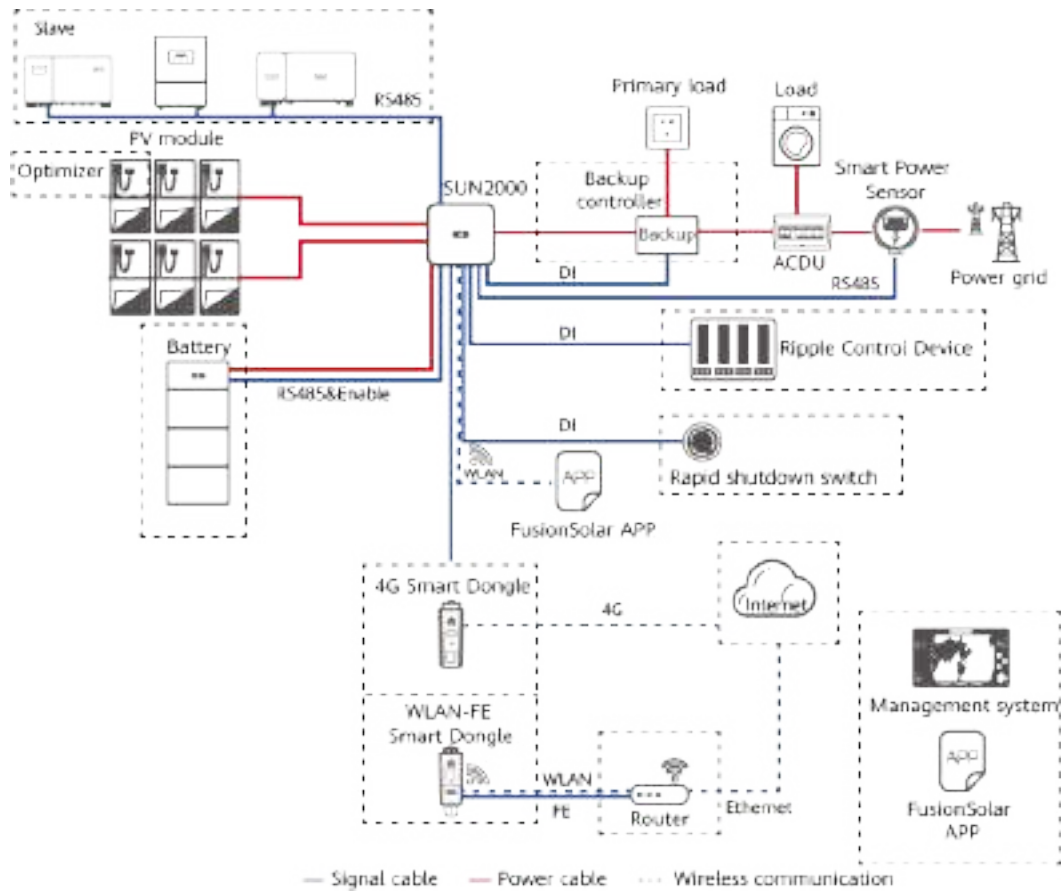

NOTE

- If the built-in Wi-Fi module of the SUN2000 connects to the app, only device commissioning can be performed.
- If inverters are cascaded without any battery, the main inverter model can be SUN2000-(3KTL-10KTL)-M1 Series. The slave inverter model can be SUN2000-(3KTL-10KTL)-M1 Series, SUN2000-(8KTL-20KTL)-M2, SUN2000-(20KTL-40KTL)-M3, SUN2000-(5KTL-20KTL)-M0, SUN2000-50KTL/60KTL/65KTL-M0, SUN2000-29.9KTL/36KTL, or SUN2000-33KTL-A.
- If inverters are cascaded with an ESS, M1/M2/M5/MB0 can be cascaded. Each M1 can connect to a maximum of two ESSs, and each MB0 can connect to a maximum of four ESSs. In the Smart Dongle networking scenario, a maximum of three inverters and six ESSs can be connected.
- For details about the EMMA networking scenario, see the [Residential Smart PV Solution Quick Guide \(Three-Phase PV+ESS Scenario + EMMA Networking\)](#).

NOTE

For detailed operations on devices in the network, see the following guides:

- [SUN2000-450W-P Smart PV Optimizer Quick Guide](#)
- [LUNA2000-\(5-30\)-50 User Manual](#)
- [Backup Box-\(B0, B1\) Quick Guide](#)

CAUTION

The off-grid load output port of the Backup Box cannot be directly connected to the power grid. Otherwise, the Backup Box will be shut down due to overload.

NOTE

- For a PV string connected to an MPPT circuit, the model, quantity, orientation, and tilt angle of PV modules in the PV string must be the same.
- The voltage of different MPPT circuits must be the same.
- The MPPT voltage must be greater than the lower threshold of the full-load MPPT range specified in the inverter technical data sheet. Otherwise, the inverter will be derated, causing the system yield loss.

Supported Power Grid Types

The SUN2000 supports TN-S, TN-C, TN-C-S, TT, and IT power grids.

Figure 2-3 Power grid types

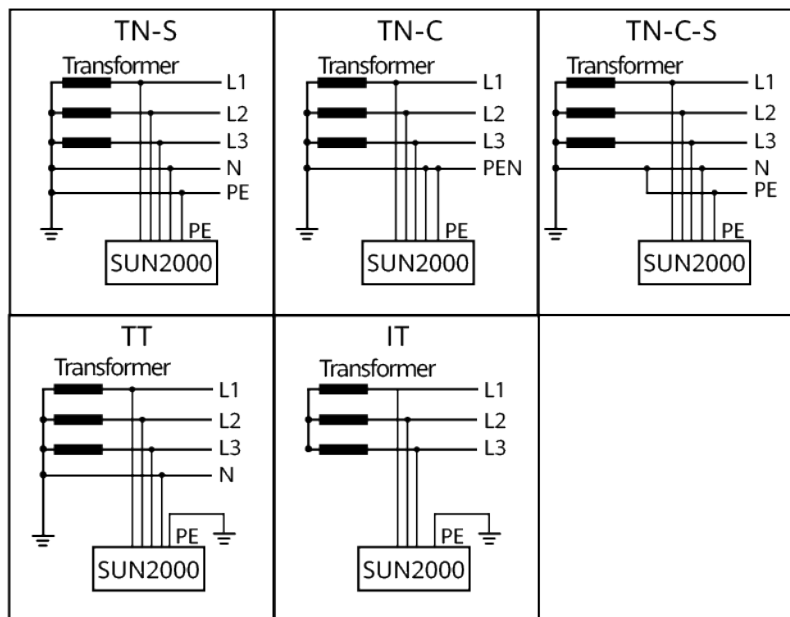

IS01S10001

NOTE

- When the SUN2000 is used in the TT power grid, the N-to-PE voltage must be less than 30 V.
- When the SUN2000 is used in the IT power grid, set **Isolation** to **Input ungrounded, with TF**.

2.2 Appearance

Figure 2-4 Appearance

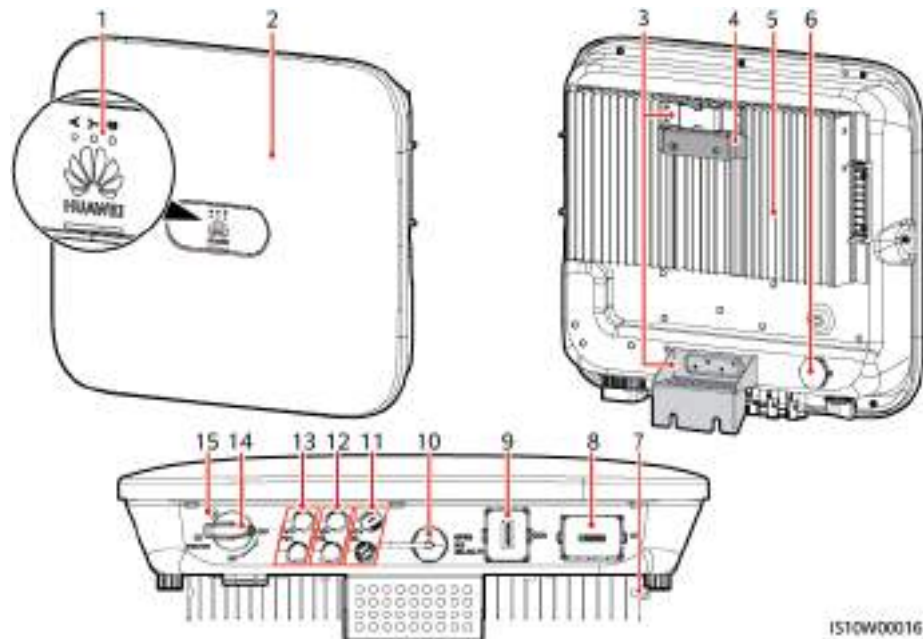

- (1) LED indicator
- (2) Front panel
- (3) Hanging kit
- (4) Mounting bracket
- (5) Heat sink
- (6) Ventilation valve
- (7) Ground screw
- (8) AC output port (AC)
- (9) Communications port (COM)
- (10) Smart Dongle port (GPRS/4G/WLAN-FE)
- (11) Battery terminals (BAT+/BAT-)
- (12) DC input terminals (PV2+/PV2-)
- (13) DC input terminals (PV1+/PV1-)
- (14) DC switch (DC SWITCH)
- (15) Hole for the DC switch locking screw

NOTE

Two M6 screw holes are reserved on the left and right sides of the SUN2000 for installing the awning.

Table 2-2 Indicator description

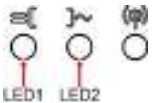

Category	Status		Description
Running indicator 	LED1	LED2	-
	Steady green	Steady green	The SUN2000 is operating in grid-tied mode.







Category	Status	Description	
	Blinking green at long intervals (on for 1s and then off for 1s)	Off	The DC is on and the AC is off.
	Blinking green at long intervals (on for 1s and then off for 1s)	Blinking green at long intervals (on for 1s and then off for 1s)	Both the DC and AC are on, and the SUN2000 is not supplying power to the power grid.
	Off	Blinking green at long intervals (on for 1s and then off for 1s)	The DC is off and the AC is on.
	Steady orange	Steady orange	The SUN2000 is operating in the off-grid mode.
	Blinking orange slowly	Off	The DC is on, and the SUN2000 has no output in the off-grid mode.
	Blinking orange slowly	Blinking orange slowly	The SUN2000 is operating in the overload in backup mode.
	Off	Off	Both the DC and AC are off.
	Blinking red at short intervals (on for 0.2s and then off for 0.2s)	-	DC environment alarm. For example, the input voltage of the PV string is high, the PV string is reversely connected, or the insulation resistance is low.
	-	Blinking red at short intervals	AC environment alarm. For example, the power grid is undervoltage, overvoltage, overfrequency, or underfrequency.
	Steady red	Steady red	Fault

Category	Status			Description
Communica tions indicator 	LED3			-
	Blinking green at short intervals (on for 0.2s and then off for 0.2s)			Communication is in progress. (When a mobile phone is connected to the SUN2000, the indicator blinks green at long intervals, indicating that the phone is connected to the SUN2000.)
	Blinking green at long intervals (on for 1s and then off for 1s)			Mobile phone access
	Off			No communication
Device replacement indicator	LED1	LED2	LED3	-
	Steady red	Steady red	Steady red	The SUN2000 hardware is faulty and the SUN2000 needs to be replaced.

2.3 Label Description

2.3.1 Enclosure Labels

Symbol	Name	Description
	Delay discharge	Residual voltage exists after the SUN2000 is powered off. It takes 5 minutes for the SUN2000 to discharge to the safe voltage.
	Burn warning	Do not touch a running SUN2000 because it generates high temperatures on the shell.

Symbol	Name	Description
	Electric shock warning	<ul style="list-style-type: none"> High voltage exists after the SUN2000 is powered on. Only qualified and trained electrical technicians are allowed to perform operations on the SUN2000. High touch current exists after the SUN2000 is powered on. Before powering on the SUN2000, ensure that the SUN2000 is properly grounded.
	Refer to documentation	Reminds operators to refer to the documents delivered with the SUN2000.
	Grounding label	Indicates the position for connecting the PE cable.
	Operation warning	Do not remove the DC input connector or AC output connector when the SUN2000 is running.
	SUN2000 serial number	Indicates the serial number.
	SUN2000 MAC address	Indicates the MAC address.
	SUN2000 Wi-Fi login QR code	Scan the QR code to connect to the Huawei SUN2000 Wi-Fi network.

2.3.2 Product Nameplate

Figure 2-5 Nameplate (using SUN2000-10KTL-M1 as an example)



(1) Trademark and product model

(2) Key technical parameters

(3) Certification marks

(4) Company name and country of origin

NOTE

The nameplate figure is for reference only.

2.4 Working Principles

2.4.1 Circuit Diagram

Two PV strings connect to the SUN2000, and their maximum power points are tracked by two maximum power point tracking (MPPT) circuits. The SUN2000 converts DC power into three-phase AC power through an inverter circuit. Surge protection is supported on both the DC and AC sides.

Figure 2-6 SUN2000 conceptual diagram

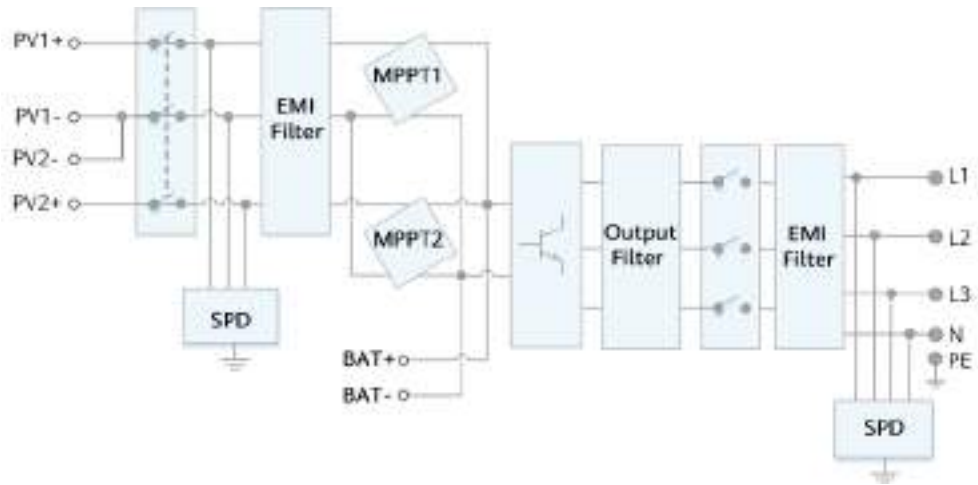

2.4.2 Working Modes

The inverter can work in Standby, Operating, or Shutdown mode.

Figure 2-7 Working modes

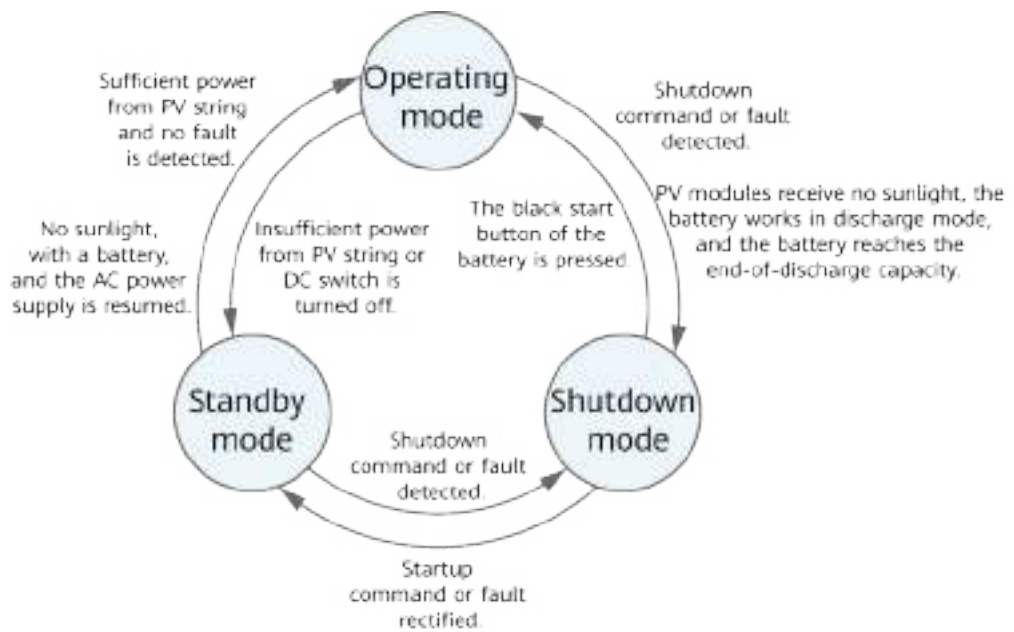

TS67500002

Table 2-3 Working mode description

Working Mode	Description
Standby	The inverter enters Standby mode when the external environment does not meet the operating requirements. In Standby mode: <ul style="list-style-type: none"> ● The inverter continuously performs status check and enters the Operating mode once the operating requirements are met. ● The inverter enters Shutdown mode after detecting a shutdown command or a fault after startup.
Operating	In Operating mode: <ul style="list-style-type: none"> ● The inverter converts DC power from PV strings into AC power and feeds the power to the power grid. ● The inverter tracks the maximum power point to maximize the PV string output. ● If the inverter detects a fault or a shutdown command, it enters the Shutdown mode. ● The inverter enters Standby mode after detecting that the PV string output power is not suitable for connecting to the power grid for generating power. ● If the PV modules receive no sunlight, the battery works in discharge mode, and the battery reaches the end-of-discharge capacity, the inverter enters Shutdown mode.
Shutdown	<ul style="list-style-type: none"> ● In Standby or Operating mode, the inverter enters Shutdown mode after detecting a fault or shutdown command. ● In Shutdown mode, the inverter enters Standby mode after detecting a startup command or that the fault is rectified. ● In Shutdown mode, if the black start button of the battery is pressed, the inverter enters Operating mode.

3 Storage

The following requirements should be met if the SUN2000 is not put into use directly:

- Do not unpack the SUN2000.
- Keep the storage temperature at -40°C to $+70^{\circ}\text{C}$ and the humidity at 5%–95% RH.
- The SUN2000 should be stored in a clean and dry place and be protected from dust and water vapor corrosion.
- A maximum of eight SUN2000s can be stacked. To avoid personal injury or device damage, stack SUN2000s with caution to prevent them from falling over.
- Periodic inspections are required during the storage. Replace the packing materials if necessary.
- If the SUN2000 has been long-term stored, inspections and tests should be conducted by qualified personnel before it is put into use.

4 Installation

- [4.1 Checking Before Installation](#)
- [4.2 Tools](#)
- [4.3 Determining the Installation Position](#)
- [4.4 Moving the SUN2000](#)
- [4.5 Installing the Mounting Bracket](#)

4.1 Checking Before Installation

Outer Packing Materials

Before unpacking the inverter, check the outer packing materials for damage, such as holes and cracks, and check the inverter model. If any damage is found or the inverter model is not what you requested, do not unpack the package and contact your supplier as soon as possible.

 **NOTE**

You are advised to remove the packing materials within 24 hours before installing the inverter.

Package Contents

NOTICE











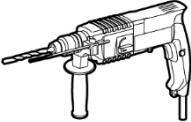
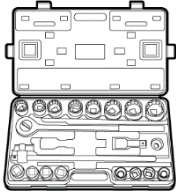
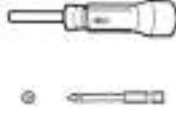

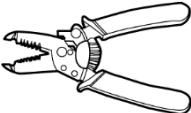
- After placing the equipment in the installation position, unpack it with care to prevent scratches. Keep the equipment stable during unpacking.



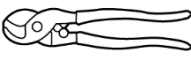



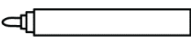
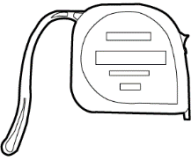

After unpacking the inverter, check that the contents are intact and complete. If any damage is found or any component is missing, contact your supplier.

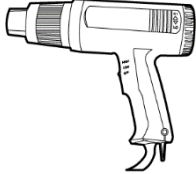
 **NOTE**

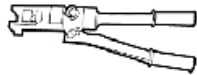
For details about the number of contents, see the *Packing List* in the packing case.

4.2 Tools

Type	Tool			
Installation Tools	 Hammer drill Drill bit: $\Phi 8$ mm and $\Phi 6$ mm	 Socket wrench set	 Torque screwdriver Phillips head: M3	 Diagonal pliers
	 Wire stripper	 Removal wrench Model: PV-MS-HZ Open-end Wrench; manufacturer: Staubli	 Rubber mallet	 Utility knife
	 Cable cutter	 Crimping tool Model: PV-CZM-22100/19100; manufacturer: Staubli	 Multimeter DC voltage measurement range ≥ 1100 V DC	 Vacuum cleaner
	 Marker	 Measuring tape	 Bubble or digital level	 Cord end terminal crimper

Type	Tool			
	 Heat shrink tubing	 Heat gun	 Cable tie	 Hydraulic pliers
PPE	 Insulated gloves	 Protective gloves	 Dust mask	 Safety shoes
	 Safety goggles	-	-	-

4.3 Determining the Installation Position

4.3.1 Environment Requirements

Basic Requirements

- The SUN2000 is protected to IP65 and can be installed indoors or outdoors.
- Do not install the SUN2000 in a place where personnel are easy to come into contact with its enclosure and heat sinks, because these parts are extremely hot during operation.
- Do not install the SUN2000 in areas with flammable or explosive materials.
- Do not install the SUN2000 at a place within children's reach.
- Do not install the SUN2000 outdoors in salt areas because it will be corroded there and may cause fire. A salt area refers to the region within 500 meters from the coast or prone to sea breeze. The regions prone to sea breeze vary depending on weather conditions (such as typhoons and monsoons) or terrains (such as dams and hills).
- The SUN2000 must be installed in a well-ventilated environment to ensure good heat dissipation.
- Recommended: Install the SUN2000 in a sheltered place or a place with an awning.

Mounting Structure Requirements

- The mounting structure where the SUN2000 is installed must be fireproof.
- Do not install the SUN2000 on flammable building materials.
- The SUN2000 is heavy. Ensure that the installation surface is solid enough to bear the weight load.
- In residential areas, do not install the SUN2000 on drywalls or walls made of similar materials which have a weak sound insulation performance because the noise generated by the SUN2000 is noticeable.

4.3.2 Space Requirements

Installation Angle Requirements

The SUN2000 can be wall-mounted or pole-mounted. The installation angle requirements are as follows:

- Install the SUN2000 vertically or at a maximum back tilt of 15 degrees to facilitate heat dissipation.
- Do not install the SUN2000 at forward tilted, excessive back tilted, side tilted, horizontal, or upside down positions.

Figure 4-1 Installation tilts

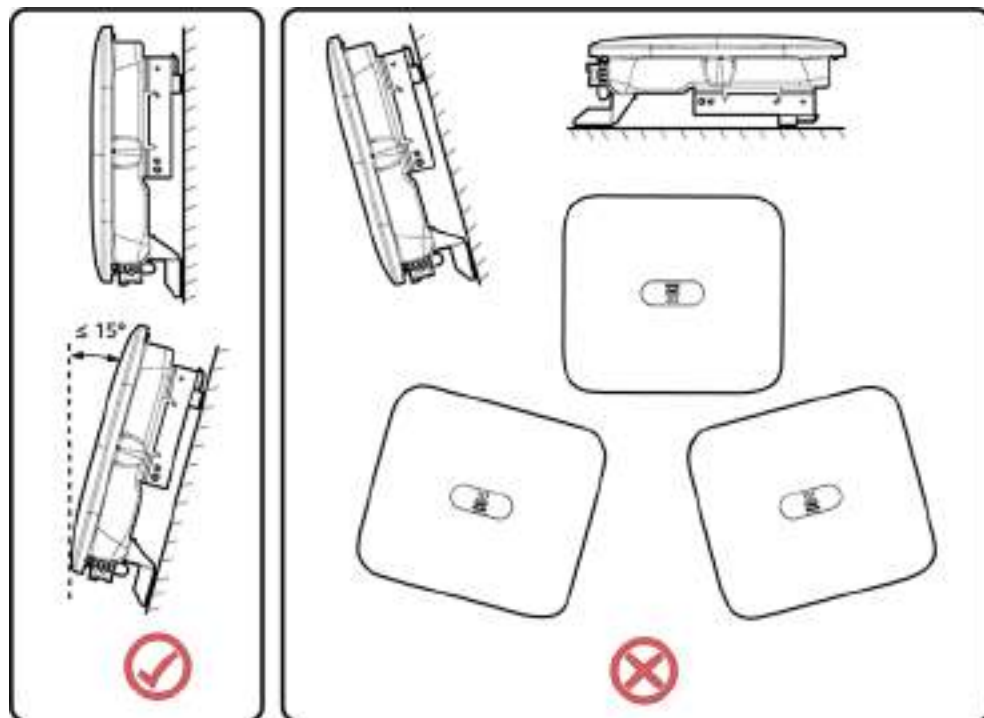

IS10H00012

Installation Space Requirements

- Reserve enough space around the SUN2000 to ensure sufficient space for installation and heat dissipation.

Figure 4-2 Installation space

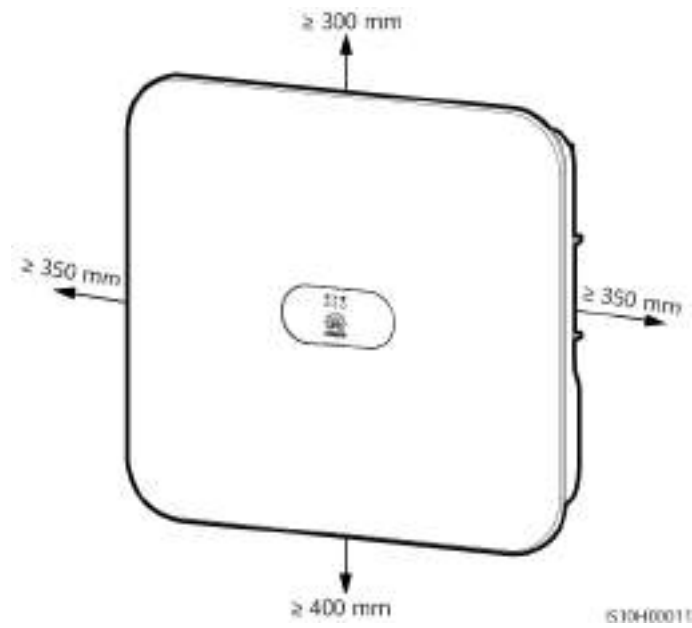

- When installing multiple SUN2000s, install them in horizontal mode if sufficient space is available and install them in triangle mode if no sufficient space is available. Stacked installation is not recommended.

Figure 4-3 Horizontal installation (recommended)

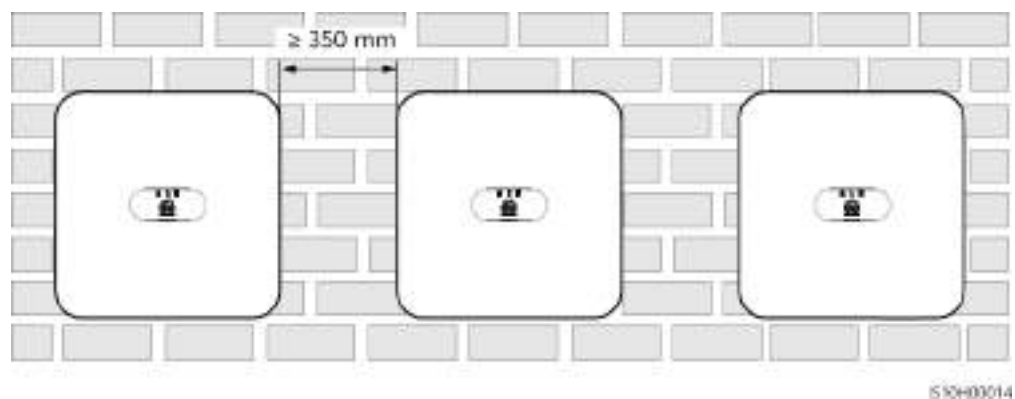
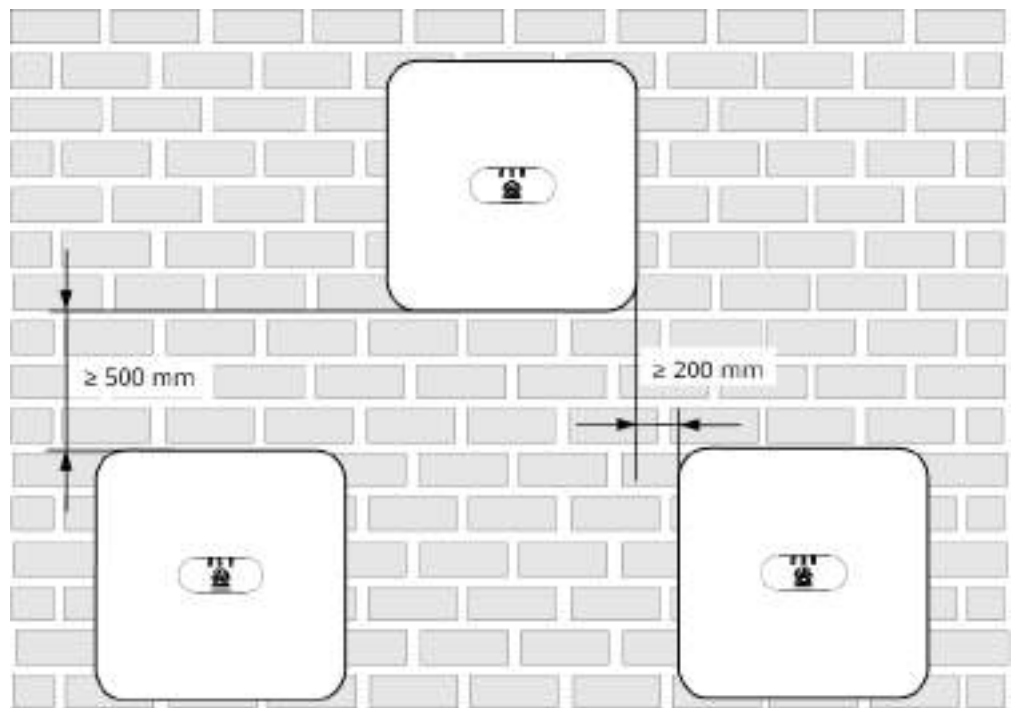
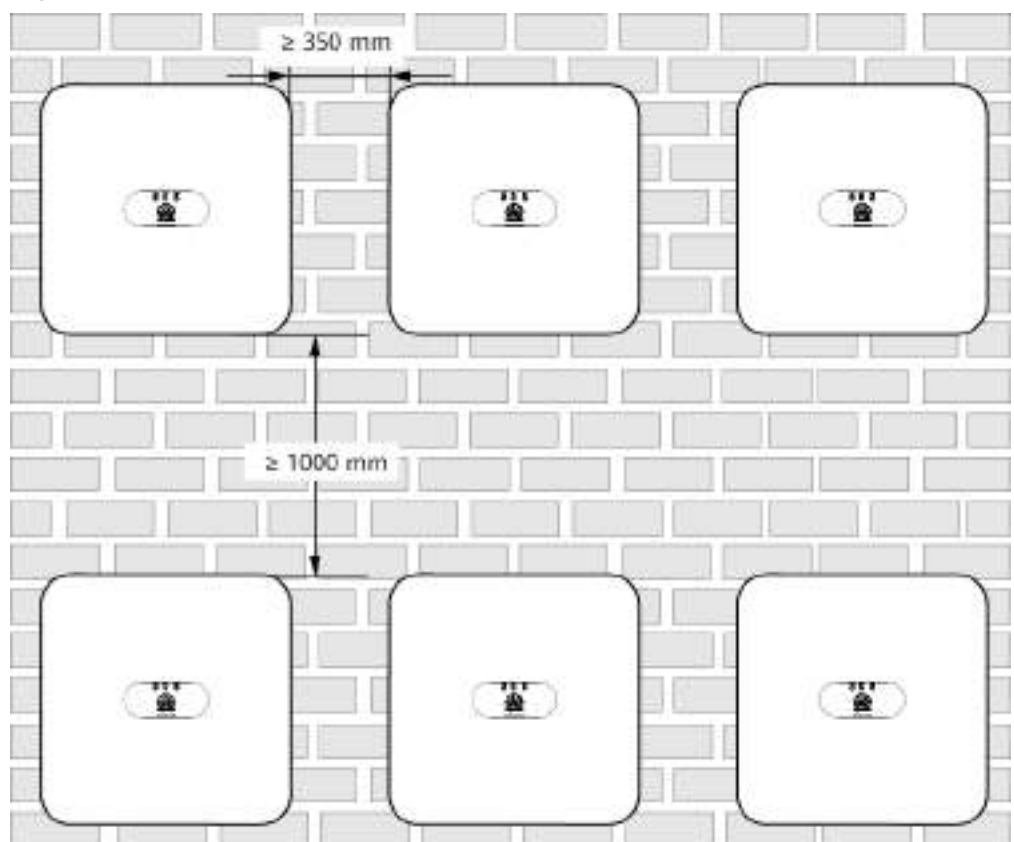

Figure 4-4 Staggered installation (recommended)



1505W00017

Figure 4-5 Stacked installation (not recommended)



1505W00016

4.4 Moving the SUN2000

Procedure

- Step 1** Two persons are required to move the SUN2000 with one person on both sides. Lift the SUN2000 from the packing case and move it to the specified installation position.

⚠ CAUTION

- Move the SUN2000 with care to prevent device damage and personal injury.
- Do not use the wiring terminals and ports at the bottom to support any weight of the SUN2000.
- Place a foam pad or cardboard under the SUN2000 to protect the SUN2000 enclosure from damage.

Figure 4-6 Moving the SUN2000

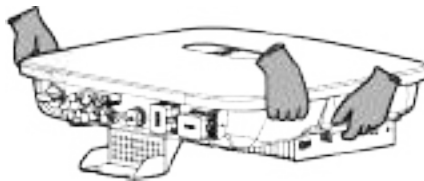

----End

4.5 Installing the Mounting Bracket

Installation Precautions

Figure 4-7 shows the dimensions of installation holes on the SUN2000.

Figure 4-7 Mounting bracket dimensions

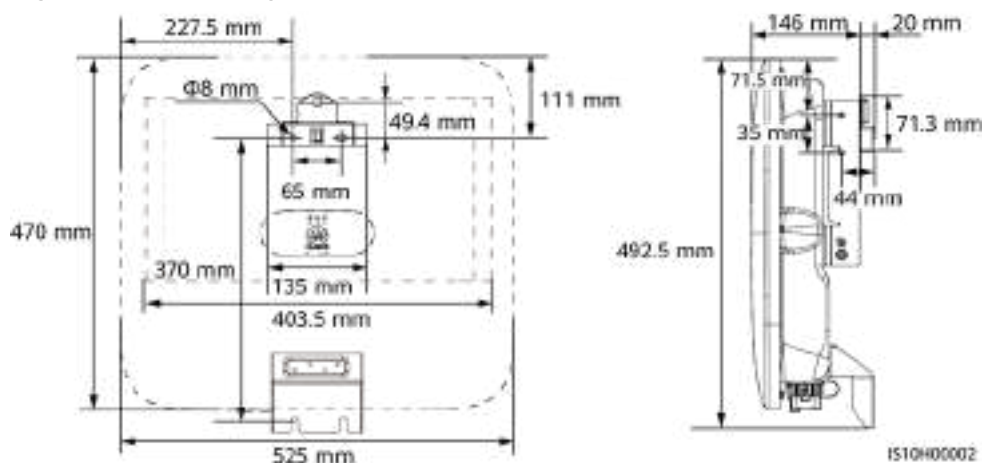

 **NOTE**

Two M6 screw holes are reserved on both left and right sides of the enclosure for installing an awning.

4.5.1 Wall-mounted Installation

Procedure

Step 1 Determine the positions for drilling holes and mark the positions using a marker.

Step 2 Secure the mounting bracket.

 **NOTE**

- M6x60 expansion bolts are delivered with the SUN2000. If the length and number of the bolts do not meet installation requirements, prepare M6 stainless steel expansion bolts by yourself.
- The expansion bolts delivered with the inverter are used for solid concrete walls. For other types of walls, prepare bolts by yourself and ensure that the wall meets the load bearing requirements of the inverter.

Figure 4-8 Expansion bolt composition

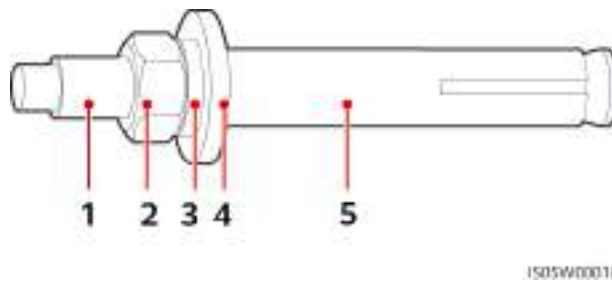

(1) Bolt

(2) Nut

(3) Spring washer

(4) Flat washer

(5) Expansion sleeve

 **DANGER**

Avoid drilling holes in the water pipes and cables buried in the wall.

NOTICE

- To prevent dust inhalation or contact with eyes, wear safety goggles and a dust mask when drilling holes.
- Clean up any dust in and around the holes using a vacuum cleaner and measure the distance between holes. If the holes are inaccurately positioned, drill holes again.
- Level the top of the expansion sleeve with the concrete wall after removing the bolt, spring washer, and flat washer. Otherwise, the mounting bracket will not be securely installed on the concrete wall.
- Loosen the nuts, flat washers, and spring washers of the two expansion bolts below.

Figure 4-9 Installing the mounting bracket

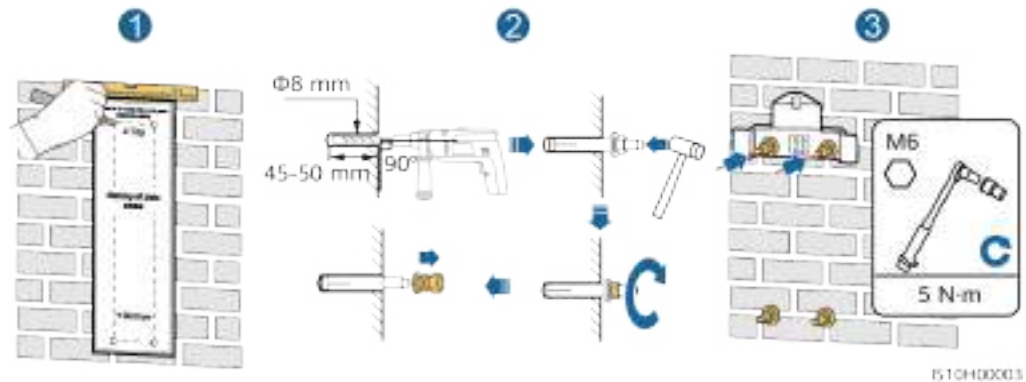

Step 3 (Optional) Install the locking screw for the DC switch.

NOTE

- The locking screw for the DC switch is delivered with the SUN2000. According to the Australian standard, the locking screw is used to secure the DC switch to prevent the SUN2000 from being started by mistake.
- For the model used in Australia, perform this step based on the local standards.

Figure 4-10 Installing the locking screw for the DC switch

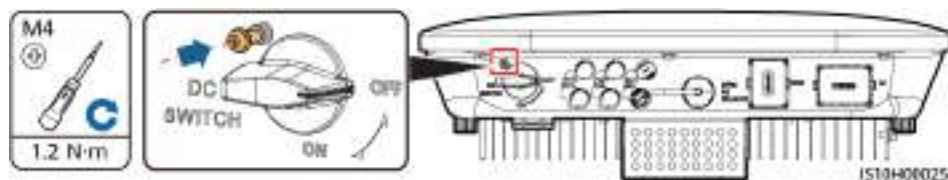

Step 4 Install the SUN2000 onto the mounting bracket.

Step 5 Tighten the nut.

Figure 4-11 Installing a SUN2000

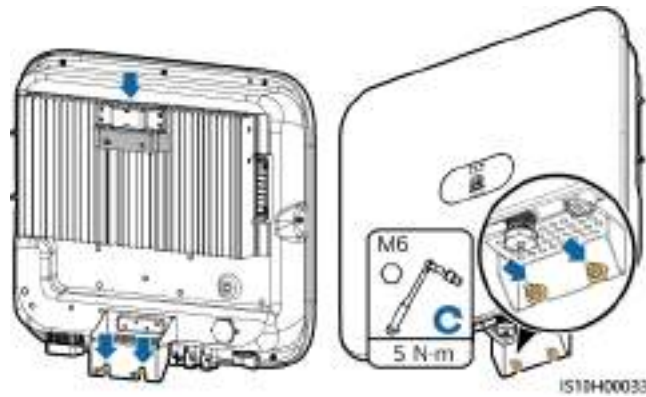

Step 6 (Optional) Install an anti-theft lock.

NOTICE

- Prepare an anti-theft lock suitable for the lock hole diameter ($\Phi 8$ mm) by yourself. Ensure that the lock can be installed successfully.
- Outdoor waterproof lock is recommended.
- Keep the key to the anti-theft lock properly.

Figure 4-12 Installing an anti-theft lock



----End

4.5.2 Support Mounting

Prerequisites

Prepare M6 stainless steel bolt assemblies (including flat washers, spring washers, and M6 bolts) with appropriate lengths as well as matched flat washers and nuts based on the support specifications.

Procedure

Step 1 Determine the positions for drilling holes using the marking-off plate, and then mark the positions with a marker.

Figure 4-13 Determining hole positions

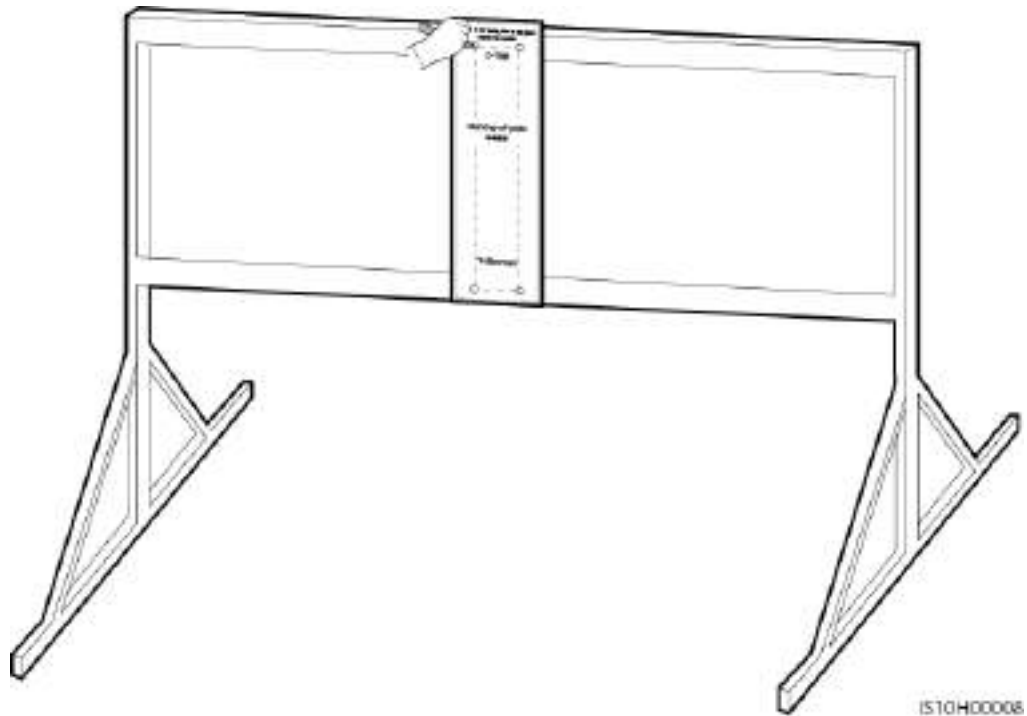

Step 2 Drill holes using a hammer drill.

NOTE

You are advised to apply anti-rust paint on the hole positions for protection.

Figure 4-14 Drilling holes

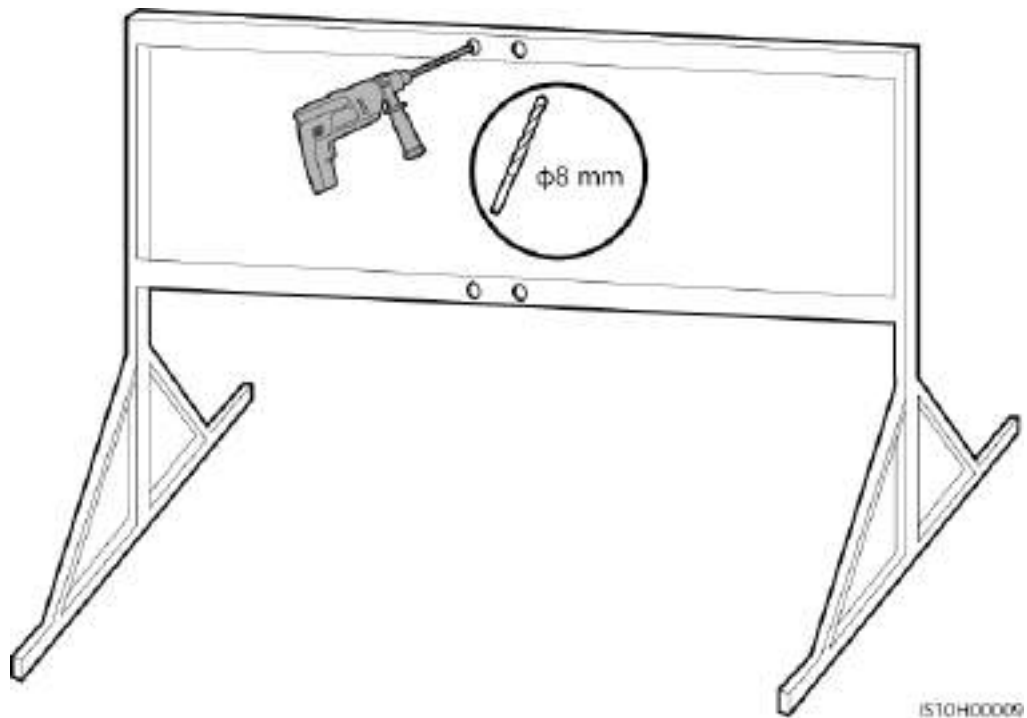

Step 3 Secure the mounting bracket.

Figure 4-15 Securing the mounting bracket

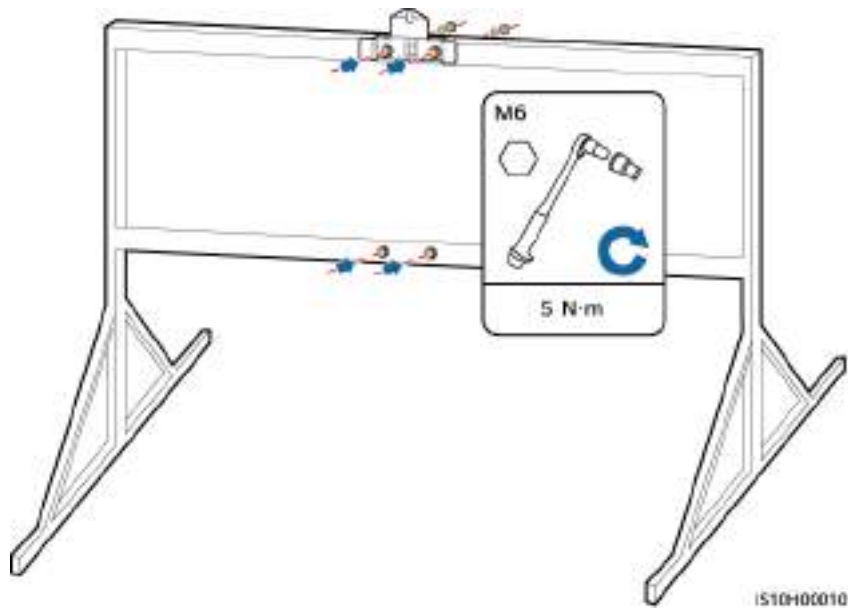

Step 4 (Optional) Install the locking screw for the DC switch.

NOTE

- The locking screw for the DC switch is delivered with the SUN2000. According to the Australian standard, the locking screw is used to secure the DC switch to prevent the SUN2000 from being started by mistake.
- For the model used in Australia, perform this step based on the local standards.

Figure 4-16 Installing the locking screw for the DC switch

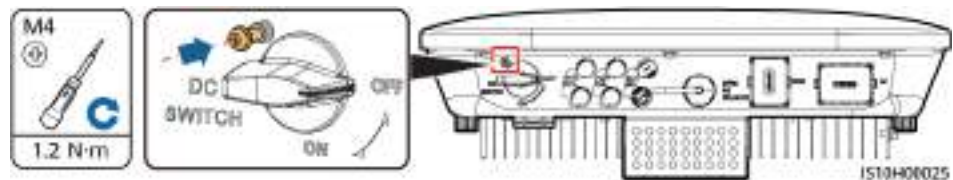

Step 5 Install the inverter on the mounting bracket.

Step 6 Tighten the bolt assemblies.

Figure 4-17 Installing a SUN2000

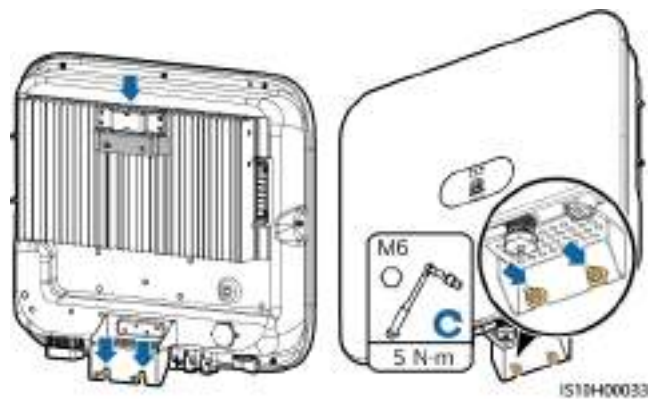

Step 7 (Optional) Install an anti-theft lock.

NOTICE

- Prepare an anti-theft lock suitable for the lock hole diameter ($\Phi 8$ mm).
 - An outdoor waterproof lock is recommended.
 - Keep the key to the anti-theft lock.
-

Figure 4-18 Installing an anti-theft lock



----End

5 Electrical Connections

- 5.1 Precautions
- 5.2 Installation Preparation
- 5.3 Connecting the PE cable
- 5.4 Connecting the AC Output Power Cable
- 5.5 Installing DC Input Power Cables
- 5.6 (Optional) Connecting Battery Cables
- 5.7 Installing the Smart Dongle
- 5.8 (Optional) Connecting the Signal Cable

5.1 Precautions

 **DANGER**

When exposed to sunlight, the PV arrays supply DC voltage to the inverter. Before connecting cables, ensure that all **DC SWITCH** on the inverter are OFF. Otherwise, the high voltage of the inverter may result in electric shocks.

 **DANGER**

- The site must be equipped with qualified fire fighting facilities, such as fire sand and carbon dioxide fire extinguishers.
 - Wear personal protective equipment and use dedicated insulated tools to avoid electric shocks or short circuits.
-

WARNING

- The equipment damage caused by incorrect cable connections is beyond the warranty scope.
- Only certified electrician can perform electrical terminations.
- Operation personnel must wear PPE when connecting cables.
- Before connecting cables to ports, leave enough slack to reduce the tension on the cables and prevent poor cable connections.

CAUTION

- Stay away from the equipment when preparing cables to prevent cable scraps from entering the equipment. Cable scraps may cause sparks and result in personal injury and equipment damage.

NOTE

The cable colors shown in the electrical connection diagrams provided in this section are for reference only. Select cables in accordance with local cable specifications (green-and-yellow cables are only used for protective earthing).

5.2 Installation Preparation

Figure 5-1 SUN2000 cable connections (dashed boxes indicate optional components)

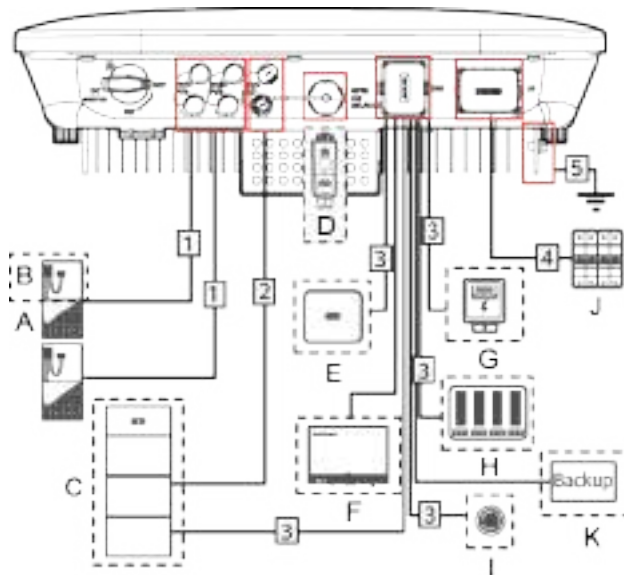

NOTICE

If a Smart Dongle is configured, it is recommended that you install it before connecting the signal cable.

Table 5-1 Component description

No.	Component	Description	Source
A	PV module	<ul style="list-style-type: none"> A PV string is composed of the PV modules connected in series and can work with an optimizer. The SUN2000 supports the input from two PV strings. 	Prepared by users
B	(Optional) Smart PV optimizer	The SUN2000-450W-P, SUN2000-450W-P2, and SUN2000-600W-P smart PV optimizers are supported.	Purchased from Huawei
C	(Optional) Battery	The LUNA2000-5-S0, LUNA2000-10-S0, and LUNA2000-15-S0 batteries can be connected to the SUN2000.	Purchased from Huawei
D	(Optional) Smart Dongle ¹	Supported models: <ul style="list-style-type: none"> WLAN-FE Smart Dongle: SDongleA-05 4G Smart Dongle: SDongleA-03 and SDongleB-06. 	Purchased from Huawei
E	(Optional) SUN2000	Select a proper model as required.	Purchased from Huawei
F	(Optional) SmartLogger	Select a proper model as required.	Purchased from Huawei
G	(Optional) Power meter ²	Recommended meter models: DTSU666-H, DTSU666-HW ³ , YDS60-80 ⁴ , YDS60-C24 ⁵ , DTSU71 and DHSU1079-CT ⁶	Purchased from Huawei
H	(Optional) Power grid scheduling device	Select the devices that meet the power grid scheduling requirements.	Provided by the local power grid company
I	(Optional) Rapid shutdown switch	Select a proper model as required.	Prepared by users

No.	Component	Description	Source
J	AC switch	<p>To ensure that the inverter can be safely disconnected from the power grid when an exception occurs, connect an AC switch to the AC side of the inverter. Select an appropriate AC switch in accordance with local industry standards and regulations. Huawei recommends the following switch specifications:</p> <p>Recommended: a three-phase AC circuit breaker with a rated voltage greater than or equal to 380 V AC and a rated current of:</p> <ul style="list-style-type: none"> • 16 A (SUN2000-3KTL-M1, SUN2000-4KTL-M1, SUN2000-5KTL-M1, and SUN2000-6KTL-M1) • 25 A (SUN2000-8KTL-M1, SUN2000-10KTL-BEM1 and SUN2000-10KTL-M1) 	Prepared by users
K	(Optional) Smart Backup Box	Select a proper model as required.	Purchased from Huawei
<p>Note 1:</p> <ul style="list-style-type: none"> • For details about how to operate the WLAN-FE Smart Dongle SDongleA-05, see <i>SDongleA-05 Smart Dongle Quick Guide (WLAN-FE)</i>. • For details about how to operate the 4G Smart Dongle SDongleA-03, see <i>SDongleA-03 Quick Guide (4G)</i>. <p>You can obtain the quick guide at https://support.huawei.com/enterprise/en/index.html by searching for the Smart Dongle model.</p> <p>Note 2: For details about meter operations, see <i>DTSU666-HW Smart Power Sensor Quick Guide</i>, <i>DTSU666-H 100 A and 250 A Smart Power Sensor User Manual</i>, and <i>YDS60-C24 Smart Power Sensor Quick Guide</i>.</p> <p>Note 3: SUN2000MA V100R001C00SPC142 and later versions can connect to DTSU666-HW power meters.</p> <p>Note 4: SUN2000MA V100R001C00SPC146 and later versions can connect to YDS60-80 power meters.</p> <p>Note 5: SUN2000MA V100R001C00SPC150 and later versions can connect to YDS60-C24 power meters.</p> <p>Note 6: SUN2000MA V100R001C00SPC160 and later versions can connect to DTSU71 and DHSU1079-CT power meters.</p>			

Table 5-2 Cable description

No.	Name	Type	Recommended Specifications
1	DC input power cable	Common outdoor PV cable in the industry (Recommended model: PV1-F)	<ul style="list-style-type: none"> • Conductor cross-sectional area: 4–6 mm² • Cable outer diameter: 5.5–9 mm
2	(Optional) Battery cable		
3	(Optional) Signal cable ^a	Outdoor shielded twisted pair	<ul style="list-style-type: none"> • Conductor cross-sectional area: 0.2–1 mm² • Cable outer diameter: 4–11 mm
4	AC output power cable ^b	Outdoor copper cable	<ul style="list-style-type: none"> • Conductor cross-sectional area: 4–6 mm² • Cable outer diameter: 10–21 mm
5	PE cable	Single-core outdoor copper-core cable	Conductor cross-sectional area: ≥ 4 mm ²
<p>Note a: When the smart power sensor and battery are connected to the SUN2000 at the same time, use a cable core with a cross-sectional area of 0.2 mm² to 0.5 mm².</p> <p>Note b: The minimum cable diameter depends on the fuse rating on the AC side.</p>			

 **NOTE**

- The minimum cable diameter should comply with the local cable standard.
- Factors influencing cable selection are as follows: rated current, type of cable, routing method, ambient temperature, and maximum desired line losses.

5.3 Connecting the PE cable

Important Notes

 **DANGER**

- Ensure that the PE cable is securely connected. Otherwise, electric shocks may occur.
 - Do not connect the N wire to the enclosure as a PE cable. Otherwise, electric shocks may occur.
-

 **NOTE**

- The PE point at the AC output port is used only as a PE equipotential point, not a substitute for the PE point on the enclosure.
- It is recommended that silica gel or paint be applied around the ground terminal after the PE cable is connected.

Supplementary Notes

The SUN2000 has the grounding detection function. This function is used to check whether the SUN2000 is properly grounded before the SUN2000 starts, or check whether the SUN2000 ground cable is disconnected when the SUN2000 is running. This function is used to check whether the SUN2000 is properly grounded under limited conditions. To ensure the safe operation of the SUN2000, properly ground the SUN2000 according to the connection requirements of the ground cable. For some power grid types, if the output side of the SUN2000 is connected to an isolation transformer, ensure that the SUN2000 is properly grounded and set **Isolation** to **Input ungrounded, with TF** to enable the SUN2000 to run properly.

- According to IEC 62109, to ensure the safe operation of the SUN2000 in the case of ground cable damage or disconnection, properly connect the ground cable of the SUN2000 and ensure that it meets at least one of the following requirements before the grounding detection function becomes invalid.
 - The ground cable is a single-core outdoor copper cable with a conductor cross-sectional area greater than or equal to 10 mm².
 - Use cables with the same diameter as the AC output power cable and ground the PE terminal on the AC connector and the ground screw on the chassis.
- In some countries and regions, the SUN2000 must have additional ground cables. Use cables with the same diameter as the AC output power cable and ground the PE terminal on the AC connector and the ground screw on the chassis.

Procedure

Step 1 Crimp OT terminals.

NOTICE

- Avoid scratching the core wire when stripping a cable.
- The cavity formed after the conductor crimp strip of the OT terminal is crimped must wrap the core wires completely. The core wires must contact the OT terminal closely.
- Wrap the wire crimping area with heat shrink tubing or PVC insulation tape. The heat shrink tubing is used as an example.
- When using a heat gun, protect devices from being scorched.

Figure 5-2 Crimping an OT terminal

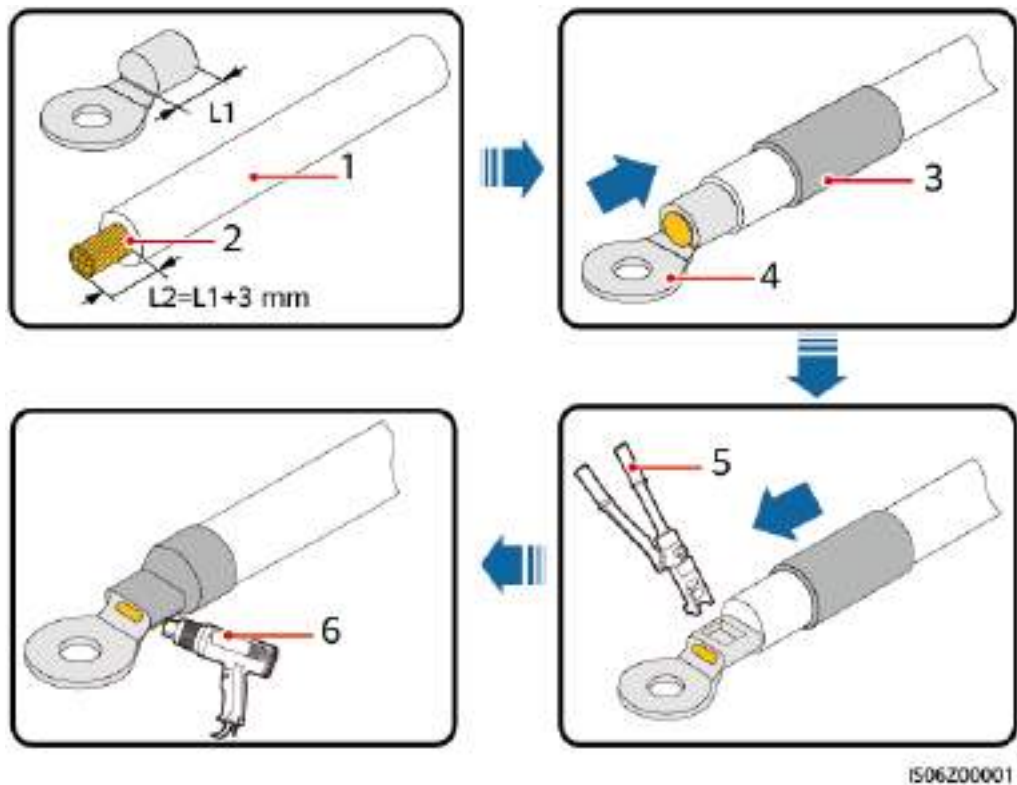

- | | | |
|-----------------|-------------------|------------------------|
| (1) Cable | (2) Core | (3) Heat shrink tubing |
| (4) OT terminal | (5) Crimping tool | (6) Heat gun |

Step 2 Connect the PE cable.

Figure 5-3 Connecting the PE cable



----End

5.4 Connecting the AC Output Power Cable

Precautions

A three-phase AC switch needs to be installed on the AC side of the SUN2000. To ensure that the SUN2000 can safely disconnect itself from the power grid when an exception occurs, select a proper overcurrent protection device in compliance with local power distribution regulations.

WARNING

- Do not connect loads between an inverter and an AC switch that directly connects to the inverter. Otherwise, the switch may trip by mistake.
- If an AC switch is used with specifications beyond local standards, regulations, or the Company's recommendations, the switch may fail to turn off in a timely manner in case of exceptions, causing serious faults.

CAUTION

Each inverter shall be equipped with an AC output switch. Multiple inverters shall not connect to the same AC switch.

The SUN2000 is integrated with a comprehensive residual current monitoring unit. Once detecting that the residual current exceeds the threshold, the SUN2000 immediately disconnects itself from the power grid.

NOTICE

- If the external AC switch can perform earth leakage protection, the rated leakage action current should be greater than or equal to 100 mA.
- If multiple SUN2000s connect to the general residual current device (RCD) through their respective external AC switches, the rated leakage action current of the general RCD should be greater than or equal to the number of SUN2000s multiplied by 100 mA.
- A knife switch cannot be used as an AC switch.

Procedure

- Step 1** Connect the AC output power cable to the AC connector.

Figure 5-4 Stripping requirements

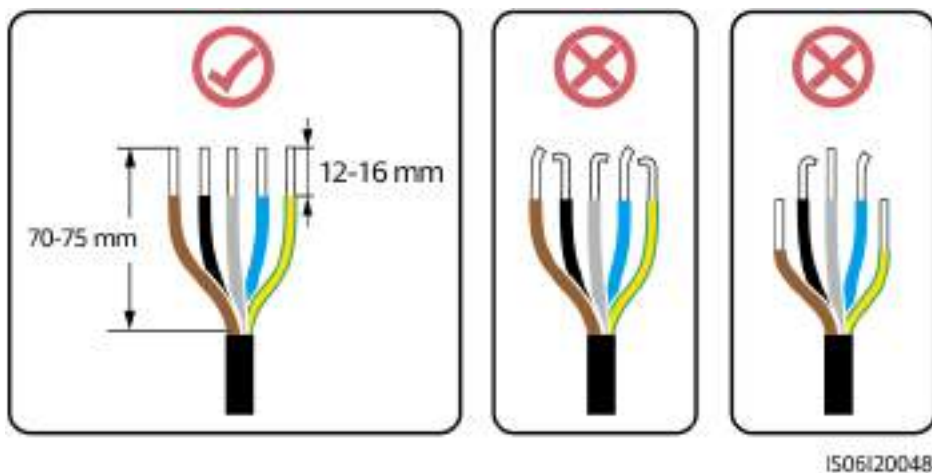

NOTICE

- Ensure that the cable jacket is inside the connector.
- Ensure that the exposed core wire is totally inserted into the cable hole.
- Ensure that AC terminations provide firm and solid electrical connections. Failing to do so may cause SUN2000 malfunction and damage to its AC connectors.
- Ensure that the cable is not twisted.

NOTICE

Strip the insulation layers of the AC output power cable by the recommended length (12–16 mm) to ensure that the cable conductors are completely inside the conductor insertion points and no insulation layer is pressed into the conductor insertion points. Otherwise, the device may fail to run properly or be damaged during operation.

Figure 5-5 Three-core cable (L1, L2, and L3)

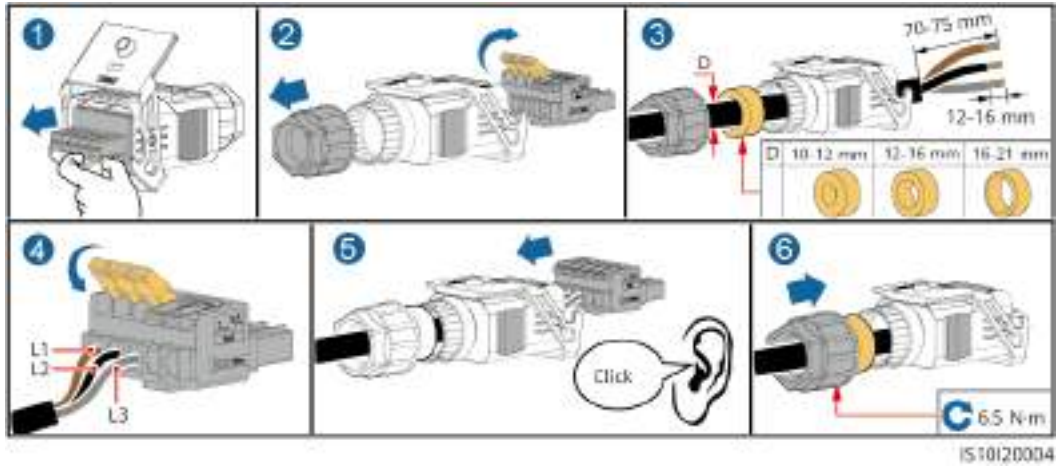

Figure 5-6 Four-core cable (L1, L2, L3, and PE)

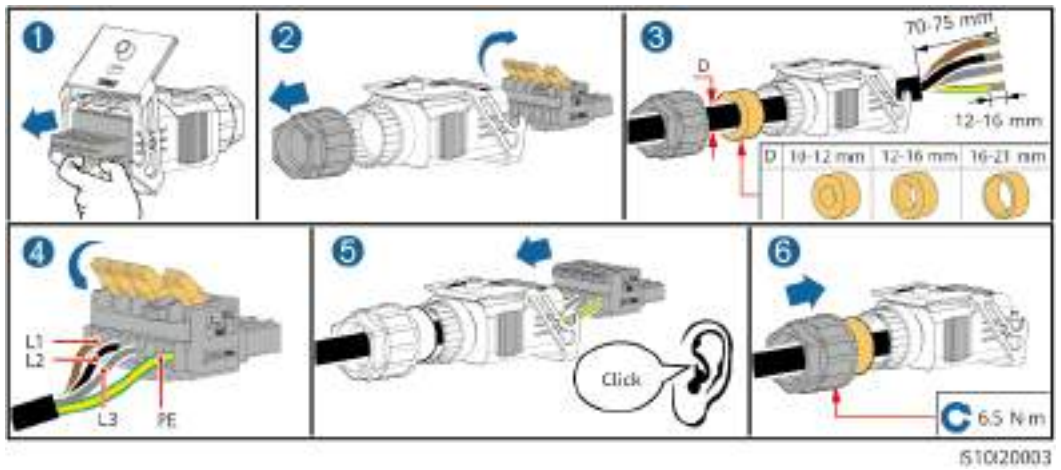

Figure 5-7 Four-core cable (L1, L2, L3, and N)

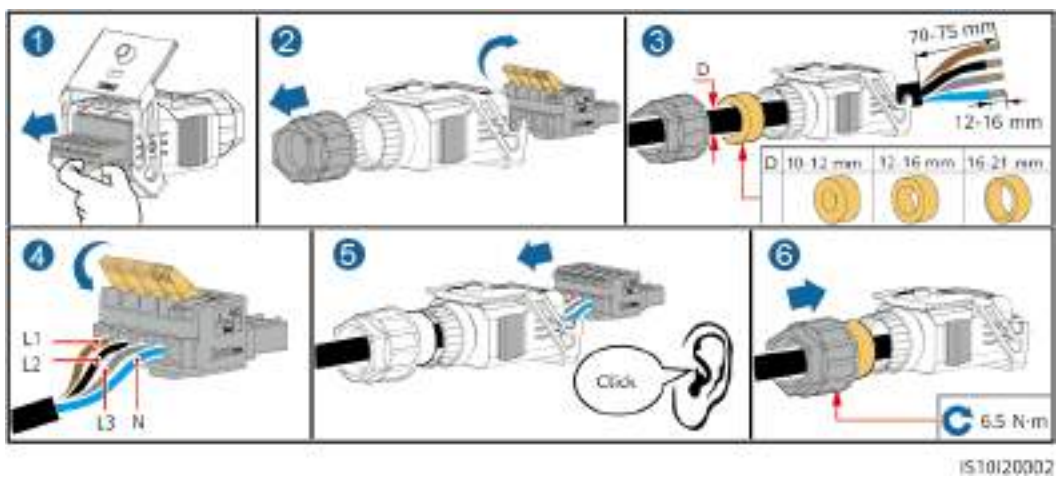
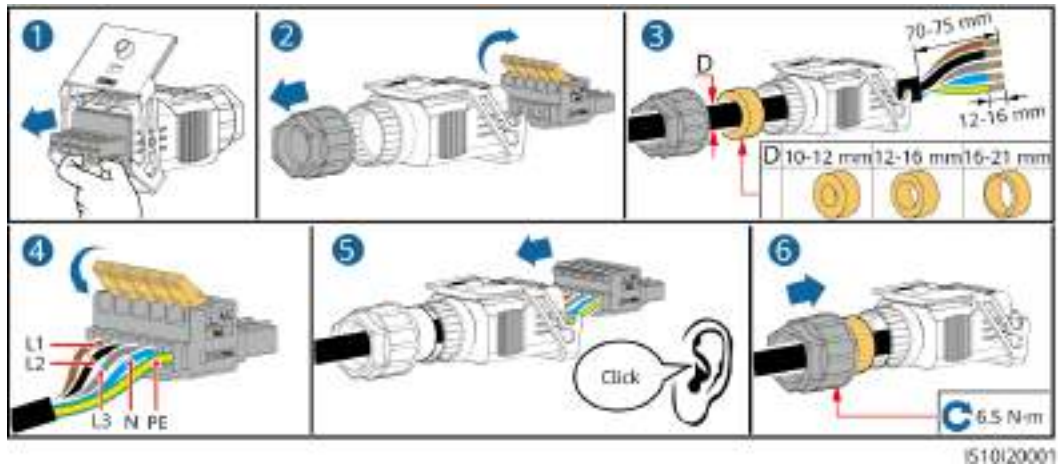

Figure 5-8 Five-core cable (L1, L2, L3, N, and PE)



NOTE

The cable colors shown in the figures are for reference only. Select an appropriate cable according to local standards.

Step 2 Connect the AC connector to the AC output port.

NOTICE

Ensure that the AC connector is connected securely.

Figure 5-9 Securing the AC connector

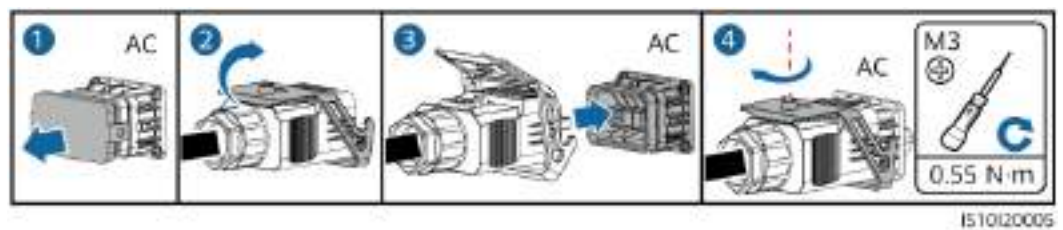

Step 3 Check the route of the AC output power cable.

Figure 5-10 Cable route

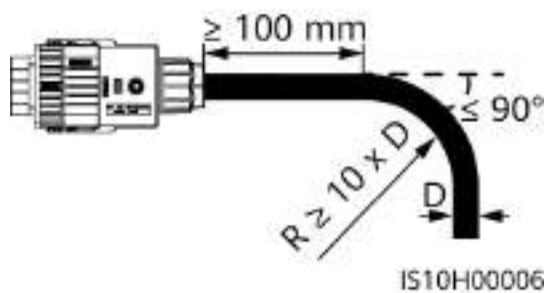

----End

Disconnection

Disconnection can be performed in reverse order.

5.5 Installing DC Input Power Cables

Important Notes

 DANGER

- Before connecting the DC input power cable, ensure that the DC voltage is within the safe range (lower than 60 V DC) and that the DC switch on the SUN2000 is OFF. Otherwise, electric shocks may occur.
 - When the SUN2000 is operating, it is not allowed to work on the DC input power cables, such as connecting or disconnecting a PV string or a PV module in a PV string. Otherwise, electric shocks may occur.
 - If no PV string connects to a DC input terminal of the SUN2000, do not remove the watertight cap from the DC input terminals. Otherwise, the IP rating of the SUN2000 will be affected.
-

 WARNING

Ensure that the following conditions are met. Otherwise, the SUN2000 may be damaged, or even fire could happen.

- PV modules connected in series in each PV string are of the same specifications.
 - The open-circuit voltage of each PV string must always be 1100 V DC or lower.
 - The maximum short-circuit current of each PV string must always be 15 A or lower.
 - The polarities of electric connections are correct on the DC input side. The positive and negative terminals of a PV string connect to corresponding positive and negative DC input terminals of the SUN2000.
 - If polarity of the DC input power cable is reversed, do not turn off the DC switch immediately or remove positive and negative connectors. Wait until the solar irradiance declines at night and the PV string current reduces to below 0.5 A, and then turn off the DC switch and remove the positive and negative connectors. Correct the PV string polarity before reconnecting the PV string to the SUN2000.
-

NOTICE

- Since the output of the PV string connected to the SUN2000 cannot be grounded, ensure that the PV module output is well insulated to ground.
- During the installation of PV strings and the SUN2000, the positive or negative terminals of PV strings may be short-circuited to ground if the power cable is not properly installed or routed. In this case, an AC or DC short circuit may occur and damage the SUN2000. The caused device damage is not covered under any warranty.

Terminal Description

Figure 5-11 Terminal

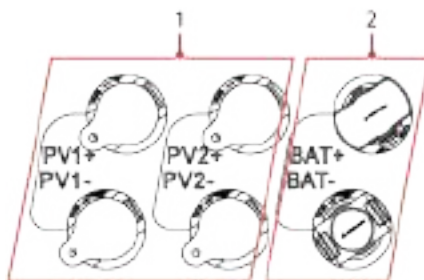

(1) DC input terminal

(2) Battery terminal

Figure 5-12 Correct wiring terminals

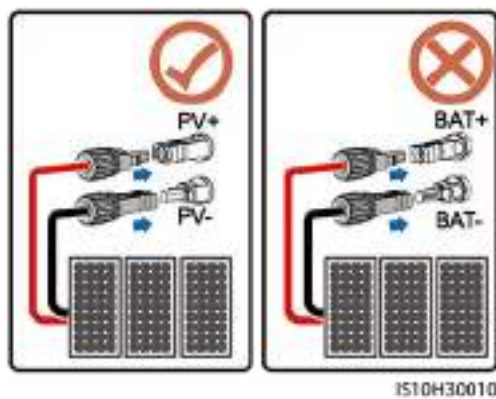

Procedure

Step 1 Install the DC input power cables.

 **WARNING**

Before inserting the positive and negative connectors into the positive and negative DC input terminals of the SUN2000, ensure that the DC switch is set to OFF.

 **CAUTION**

Use the positive and negative Staubli MC4 metal terminals and DC connectors supplied with the SUN2000. Using incompatible positive and negative metal terminals and DC connectors may result in serious consequences. The caused device damage is not covered under warranty.

NOTICE

- Cables with high rigidity, such as armored cables, are not recommended as DC input power cables, because poor contact may be caused by the bending of the cables.
 - Before assembling DC connectors, label the cable polarities correctly to ensure correct cable connections.
 - After crimping the positive and negative metal terminals, pull back the DC input power cables to ensure that they are securely connected.
 - Insert the crimped metal terminals of the positive and negative power cables into the appropriate positive and negative connectors. Then pull back the DC input power cables to ensure that they are connected securely.
 - If a DC input power cable is reversely connected and the DC switch is turned on, do not operate on the DC switch or the positive/negative connectors immediately. Otherwise, the device may be damaged. The caused device damage is not covered under any warranty. Wait until the solar irradiance declines at night and the PV string current reduces to below 0.5 A, and then turn off the DC switch and remove the positive and negative connectors. Correct the PV string polarity before reconnecting the PV string to the SUN2000.
 - During DC input power cabling, leave at least 50 mm of slack. The axial tension on PV connectors must not exceed 80 N. Radial stress or torque must not be generated on PV connectors.
-

 **NOTE**

- The DC voltage measurement range of the multimeter must be at least 1100 V.
- If the voltage is a negative value, the DC input polarity is incorrect. Correct the polarity.
- If the voltage is greater than 1100 V DC, too many PV modules configured to the same string. Remove some PV modules.
- If the PV string is configured with an optimizer, check the cable polarity by referring to the smart PV optimizer quick guide.

Figure 5-13 Installing DC input power cables

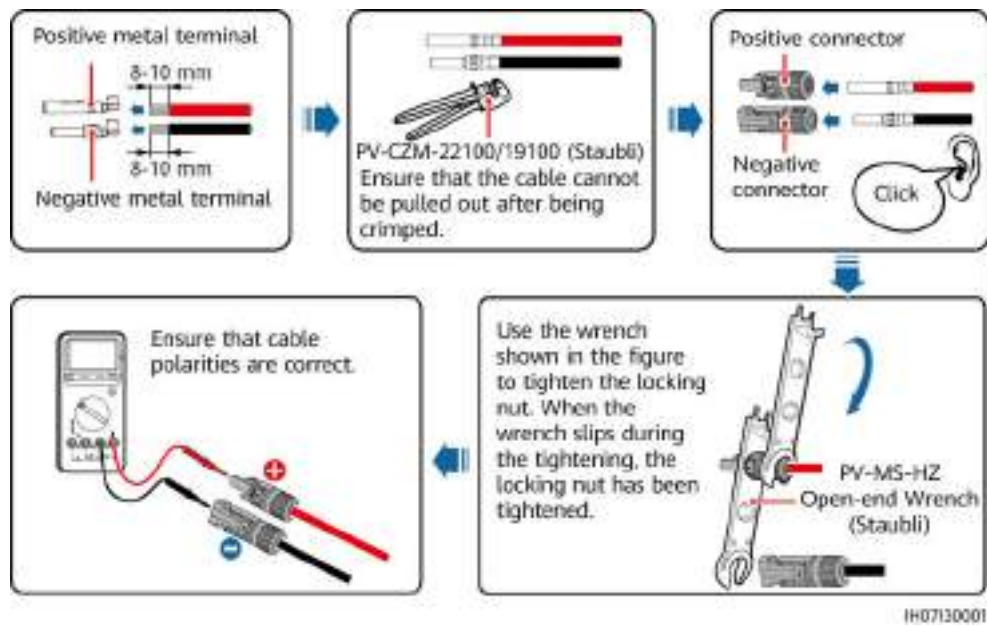

----End

Removing DC Connectors



WARNING

Before removing the positive and negative connectors, ensure that the DC switch is OFF.

To remove the positive and negative connectors from the SUN2000, insert an open-end wrench into the bayonet and press the wrench with force. Then remove the DC connectors with caution.

Figure 5-14 Removing DC connectors



5.6 (Optional) Connecting Battery Cables

Prerequisites

 **DANGER**

- Battery short-circuit may cause personal injury. The high transient current generated by a short-circuit may release a surge of energy and cause fire.
- Do not connect or disconnect the battery cables when the SUN2000 is running. Otherwise, electric shocks may occur.
- Before connecting the battery cables, ensure that the DC switch on the SUN2000 and all the switches connecting to the SUN2000 are OFF, and the SUN2000 has no residual electricity. Otherwise, the high voltage of the SUN2000 and battery may result in electric shocks.
- If no battery connects to the SUN2000, do not remove the watertight caps from the battery terminals. Otherwise, the protection level of the SUN2000 will be affected. If a battery connects to the SUN2000, set aside the watertight caps. Reinstall the watertight caps immediately after removing the connectors.

A battery switch can be configured between the SUN2000 and the battery to ensure that the SUN2000 can be safely disconnected from the battery.

 **WARNING**

- Do not connect loads between the SUN2000 and the battery.
- The battery cables should be connected correctly. That is, the positive and negative terminals of the battery connect to the positive and negative battery terminals on the SUN2000 respectively. Otherwise, the SUN2000 may be damaged, or even fire could happen.

NOTICE

- During the installation of batteries and the SUN2000, the positive or negative terminals of batteries may be short-circuited to ground if the power cable is not properly installed or routed. In this case, an AC or DC short circuit may occur and damage the SUN2000. The caused device damage is not covered under any warranty.
 - The cabling distance between the battery and the SUN2000 should be less than or equal to 10 meters (recommended: within 5 meters).
-

Procedure

- Step 1** Assemble the positive and negative connectors by referring to [5.5 Installing DC Input Power Cables](#).

⚠ DANGER

- The battery voltage may result in serious injury. Use dedicated insulation tools when connecting cables.
- Ensure that cables are correctly connected between the battery terminal and the battery switch, and between the battery switch and the SUN2000 battery terminal.

NOTICE

Cables with high rigidity, such as armored cables, are not recommended as battery cables, because poor contact may be caused by the bending of the cables.

Step 2 Insert the positive and negative connectors into corresponding battery terminals on the SUN2000.

NOTICE

After the positive and negative connectors snap into place, pull the battery cables back to ensure that they are connected securely.

Figure 5-15 Connecting battery cables

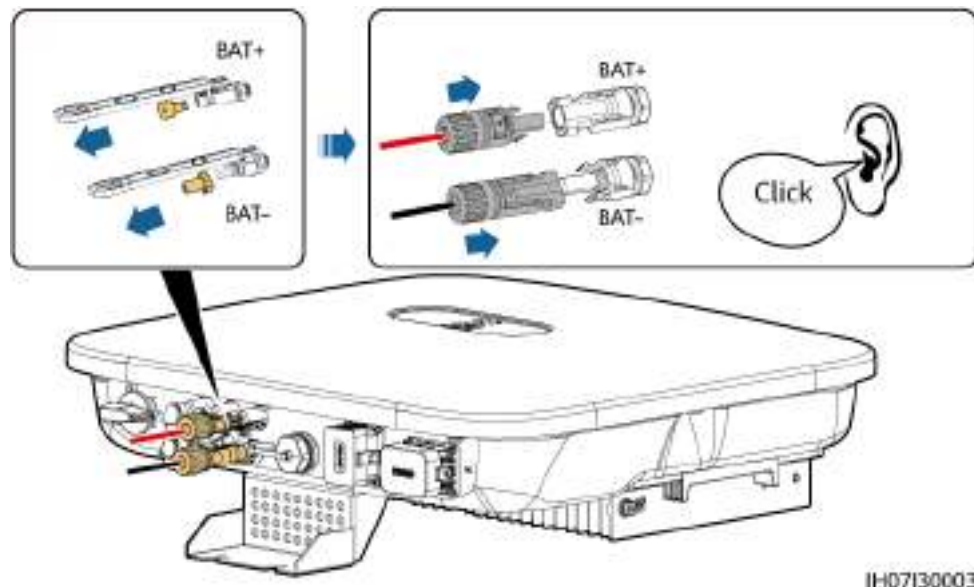

----End

5.7 Installing the Smart Dongle

Procedure

 NOTE

- If WLAN-FE communication is used, install the WLAN-FE Smart Dongle (SDongleA-05). The WLAN-FE Smart Dongle is delivered with the SUN2000.
- If 4G communication is used, install the 4G Smart Dongle (SDongleA-03). The 4G Smart Dongle needs to be purchased by the user.
- WLAN-FE Smart Dongle (FE Communication)

You are advised to use a Cat 5e outdoor shielded network cable (outer diameter < 9 mm; internal resistance ≤ 1.5 ohms/10 m) and shielded RJ45 connectors.

Figure 5-16 Installing a WLAN-FE Smart Dongle (FE communication)

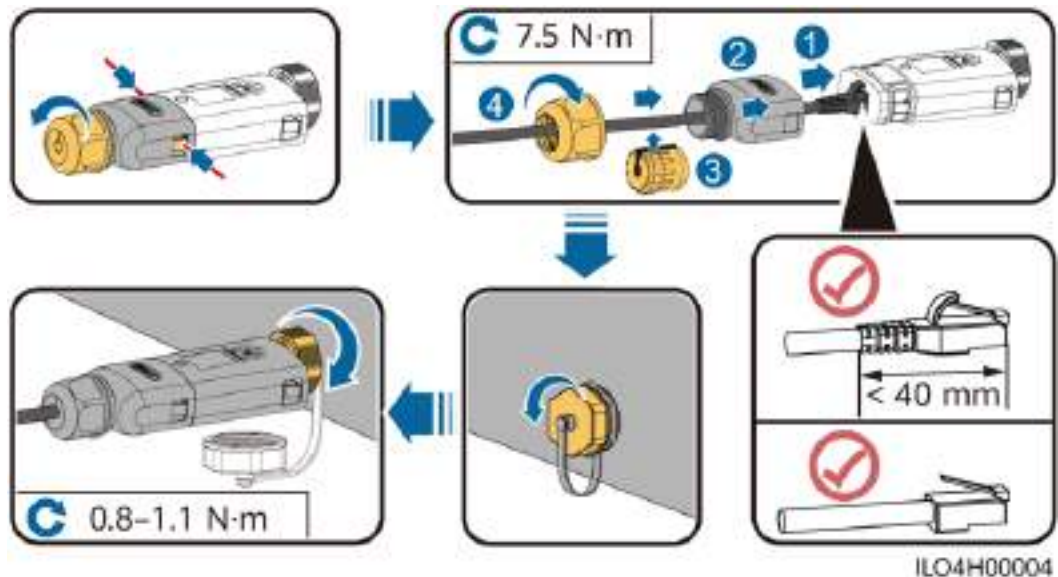

- (Optional) 4G Smart Dongle (4G communication)

 NOTE

- If your Smart Dongle is not equipped with a SIM card, prepare a standard SIM card (size: 25 mm x 15 mm) with the capacity greater than or equal to 64 KB.
- When installing the SIM card, determine its installation direction based on the silk screen and arrow on the card slot.
- Press the SIM card in place to lock it, indicating that the SIM card is correctly installed.
- When removing the SIM card, push it inwards to eject it.
- When reinstalling the shell of the Smart Dongle, ensure that the buckle springs back in place and a click sound is generated.

Figure 5-17 Installing a 4G Smart Dongle

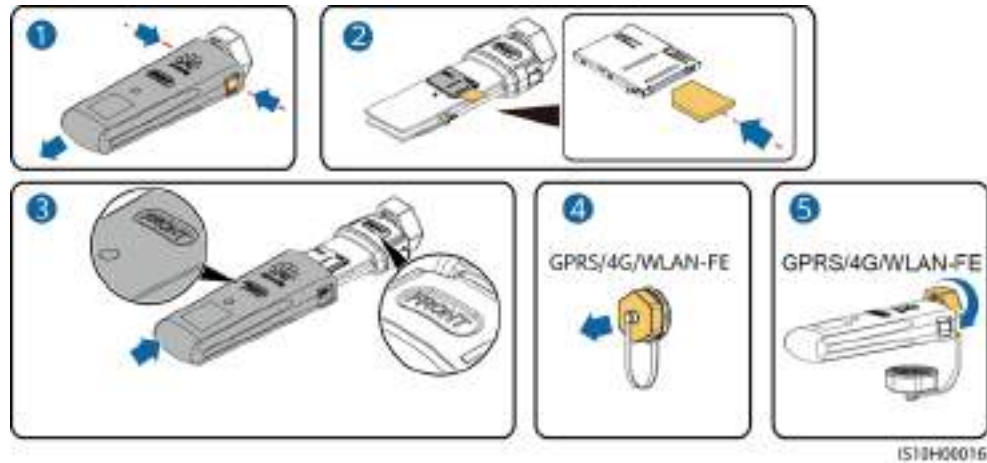

NOTE

There are two types of Smart Dongle.

- For details about how to operate the WLAN-FE Smart Dongle SDongleA-05, see [SDongleA-05 Quick Guide \(WLAN-FE\)](#). You can also scan the QR code to obtain the document.



- For details about how to operate the 4G Smart Dongle SDongleA-03, see [SDongleA-03 Quick Guide \(4G\)](#). You can also scan the QR code to obtain the document.



The quick guide is delivered with the Smart Dongle.

5.8 (Optional) Connecting the Signal Cable

COM Port Pin Definitions

NOTICE

- When laying out the signal cable, separate it from the power cable and keep it away from strong interference sources to avoid strong communication interference.
- Ensure that the protective layer of the cable is inside the connector, that excess core wires are cut off from the protection layer, that the exposed core wire is totally inserted into the cable hole, and that the cable is connected securely.

Figure 5-18 Pin definitions

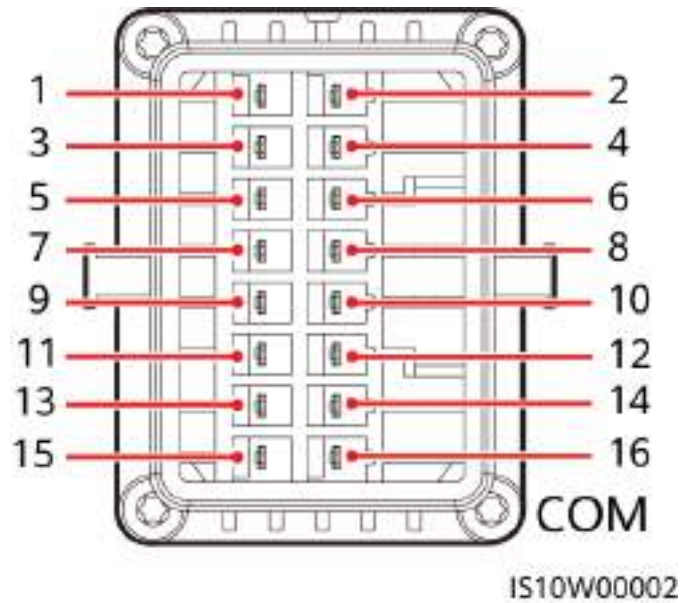

NOTE

- If the RS485 communications cables of devices such as the smart power sensor and battery are connected to the SUN2000 at the same time, the pins RS485A2 (pin 7), RS485B2 (pin 9), and PE (pin 5) are shared.
- If both the battery enable signal cable and rapid shutdown switch signal cable are connected to the SUN2000 at the same time, the GND pin (pin 13) is shared.

Pin	Definition	Functions	Remarks	Pin	Definition	Functions	Remarks
1	485A1-1	RS485A, RS485 differential signal+	Used for SUN2000 cascading or connecting to the RS485 signal port on the SmartLogger	2	485A1-2	RS485A, RS485 differential signal+	Used for SUN2000 cascading or connecting to the RS485 signal port on the SmartLogger
3	485B1-1	RS485B, RS485 differential signal-		4	485B1-2	RS485B, RS485 differential signal-	
5	PE	Ground point on the shield layer	-	6	PE	Ground point on the shield layer	-

Pin	Definition	Functions	Remarks	Pin	Definition	Functions	Remarks
7	485A2	RS485A, RS485 differential signal+	Used to connect to the RS485 signal port on a power meter or battery	8	DIN1	Digital input signal 1+	Used to connect to dry contacts for grid scheduling or serve as a port for the feedback signal of the Backup Box.
9	485B2	RS485B, RS485 differential signal-		10	DIN2	Digital input signal 2+	
11	EN	Enable signal	Used to connect to the enable signal of the battery.	12	DIN3	Digital input signal 3+	Used to connect to dry contacts for grid scheduling
13	GND	GND	-	14	DIN4	Digital input signal 4+	
15	DIN5	Rapid shutdown	Used to connect to the rapid shutdown DI signal port or serve as a port for the signal cable of the NS protection.	16	GND	GND of DI1/DI2/DI3/DI4	Used to connect to the GND of DI1/DI2/DI3/DI4

Networking Modes

- Smart Dongle networking

Figure 5-19 Smart Dongle networking (the dashed box indicates optional components)

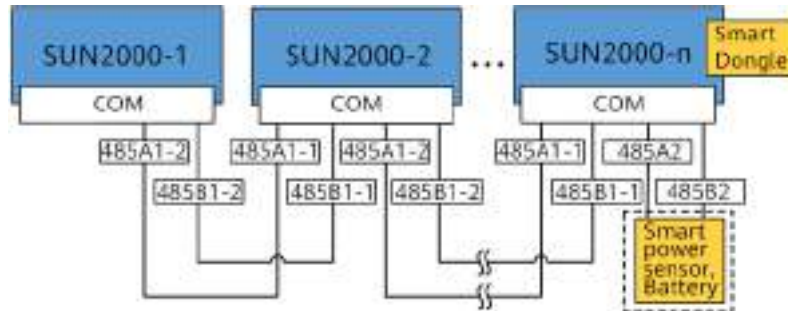

Table 5-3 Usage Restrictions

Smart Dongle	Usage Restrictions	Actual Connection	
	Maximum Number of Devices That Can Be Connected to the Smart Dongle	Number of SUN2000s	Number of Other Devices ^a
4G	10	$n \leq 10$	$\leq 10-n$
WLAN-FE	10	$n \leq 10$	$\leq 10-n$

Note a: If the power meter and battery are connected through the RS485A2 and RS485B2 ports, they are not included as cascaded devices.

NOTE

- If the SUN2000 is networked with the Smart Dongle, it cannot connect to the SmartLogger.
- The Smart Power Sensor is necessary for export limitation. Select the Smart Power Sensor according to the actual project.
- The power meter and Smart Dongle must be connected to the same SUN2000.
- If a battery is connected, a maximum of three inverters can be cascaded. Any one of the inverters can be connected to the battery. (The inverter connected to the Smart Dongle must be connected to the battery.)
- If the SUN2000-(3KTL-10KTL)-M1 Series and SUN2000-(2KTL-6KTL)-L1 are cascaded, a maximum of three inverters can be cascaded.
- SmartLogger networking

Figure 5-20 SmartLogger networking (the dashed box indicates optional components)

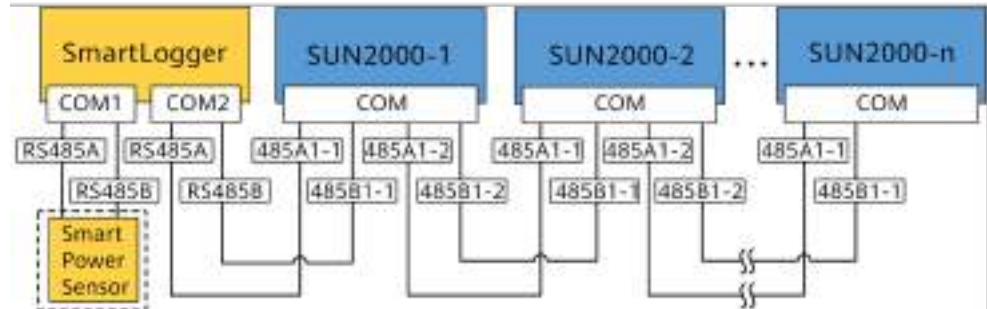

NOTE

- A maximum of 80 devices can connect to a single SmartLogger. You are advised to connect fewer than 30 devices to each RS485 route.
- If the SUN2000 is networked over the SmartLogger, it cannot connect to the Smart Dongle.
- The Smart Power Sensor is necessary for export limitation. Select the Smart Power Sensor according to the actual project.
- To ensure the system response speed, it is recommended that the power meter be connected to one COM port.

5.8.1 Connecting the RS485 Communications Cable (Inverter Cascading)

Procedure

- Step 1** Connect the signal cable to the signal cable connector.

Figure 5-21 Installing the cable

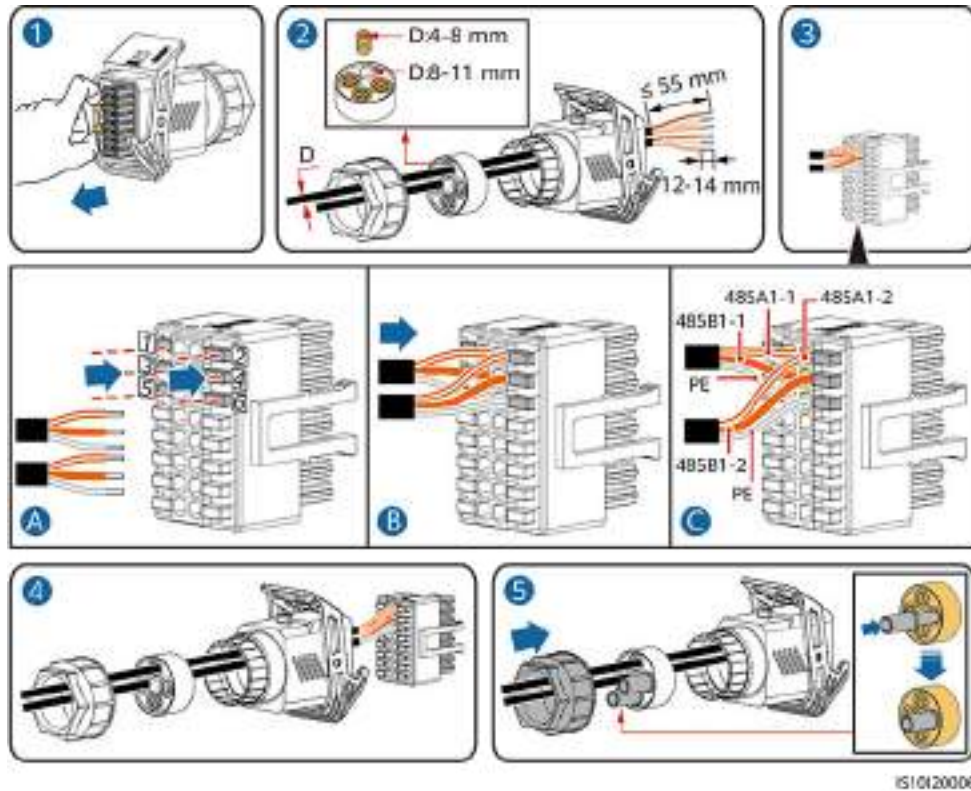

Step 2 Connect the signal cable connector to the COM port.

Figure 5-22 Securing the signal cable connector

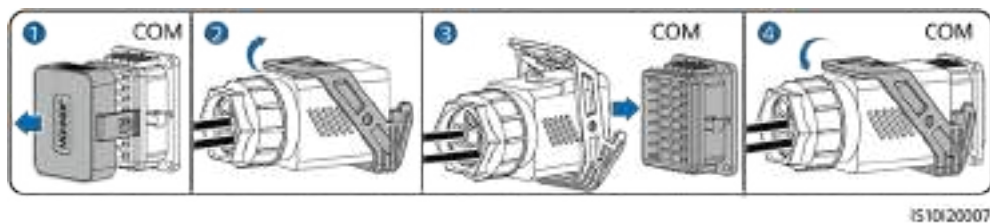

----End

5.8.2 Connecting the RS485 Communications Cable (Smart Power Sensor)

Cable Connection

- The following figures show the cable connections between the inverter and DTSU666-H and YDS60-C24 meters.

NOTE

The cable connections between the DTSU71 and DHSU1079-CT power meters and the inverter are the same as those between the DTSU666-H power meter and the inverter.

Figure 5-23 DTSU666-H three-phase, three-wire cable connection (Smart Dongle networking)

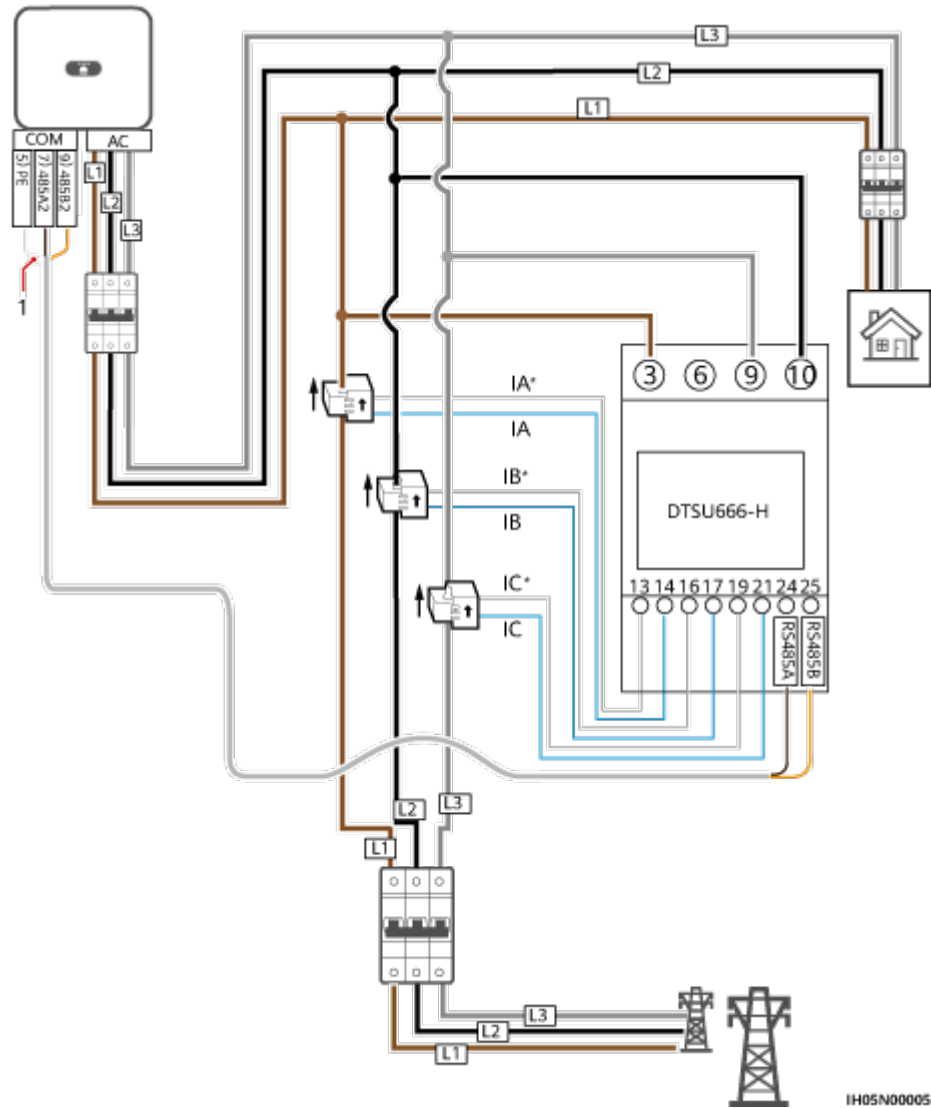
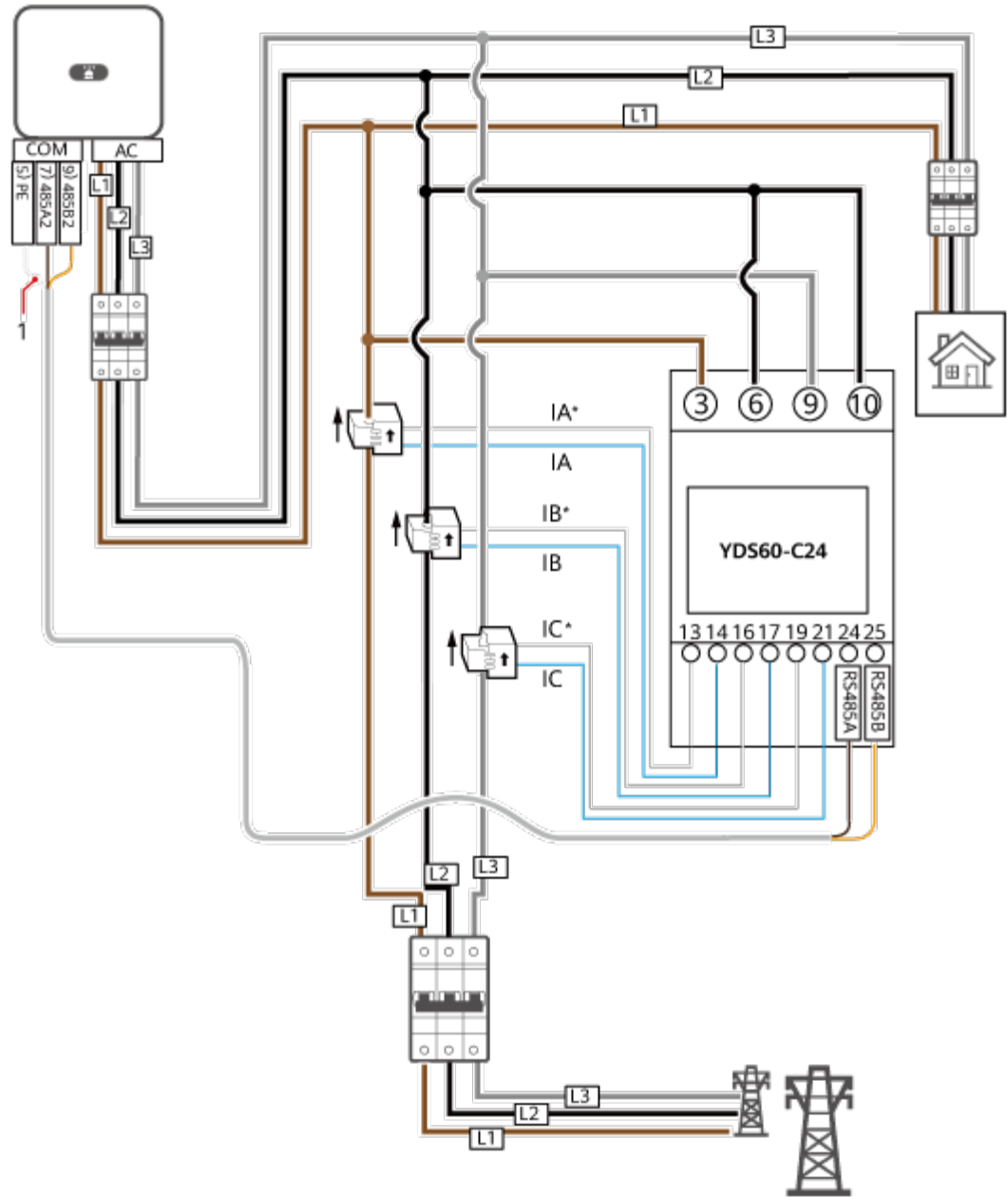
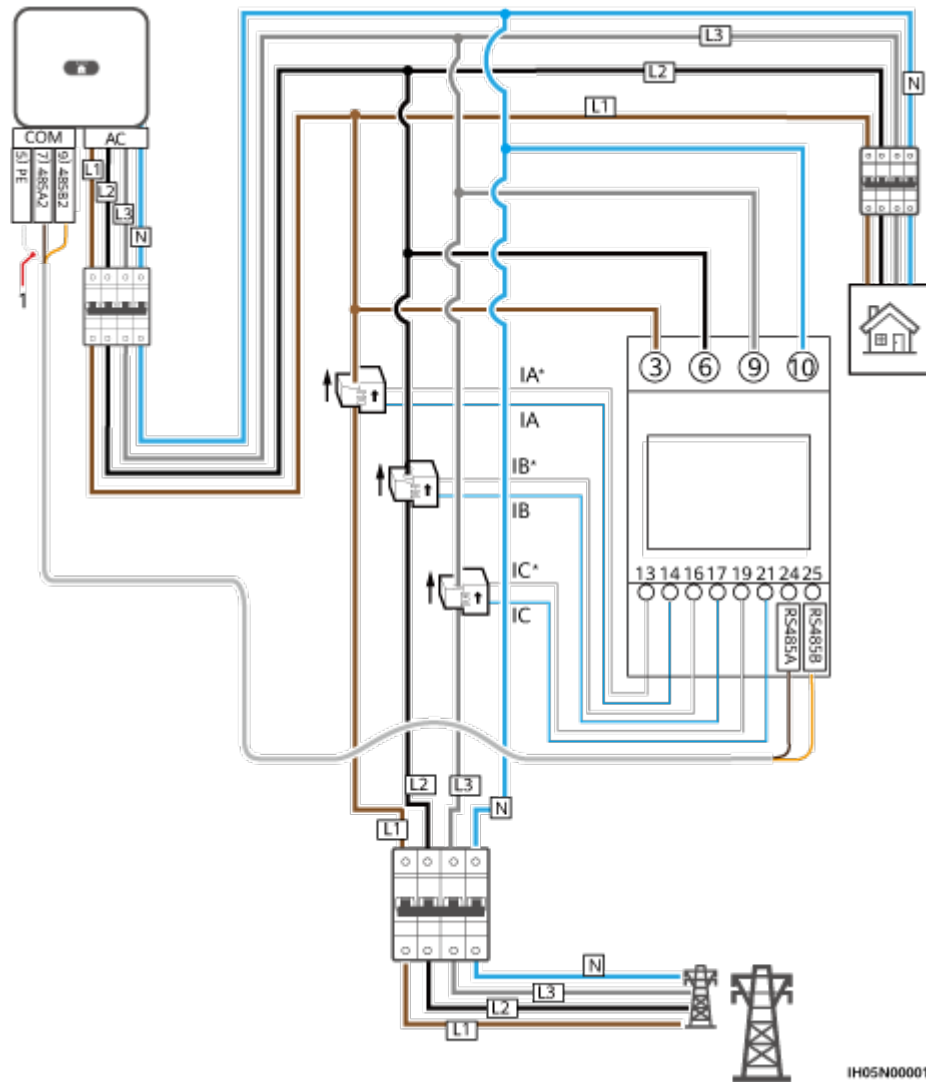

Figure 5-24 YDS60-C24 three-phase, three-wire cable connection (Smart Dongle networking)



IH05N00006

Figure 5-25 Three-phase, four-wire connection (Smart Dongle networking)



IH05N00001

- The following figure shows the cable connections between the inverter and DTSU666-HW and YDS60-80 power meters.

Figure 5-26 Three-phase, three-wire direct connection (Smart Dongle networking)

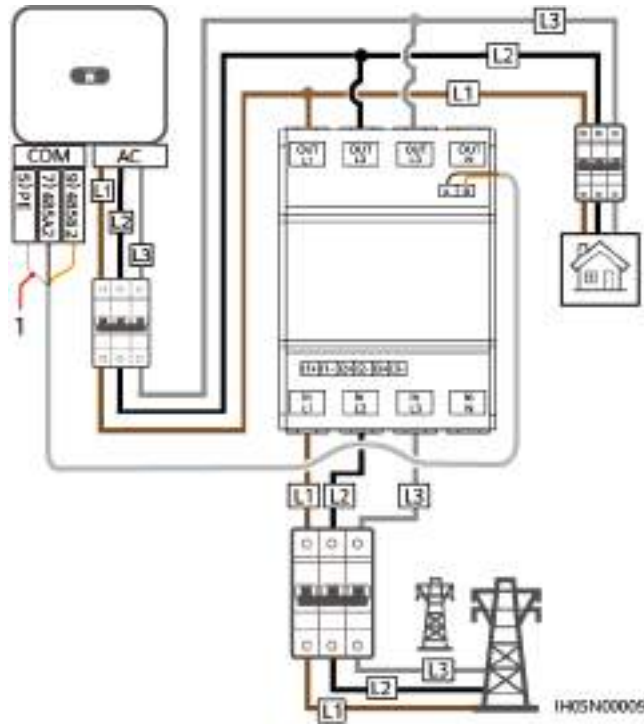

Figure 5-27 Three-phase, four-wire direct connection (Smart Dongle networking)

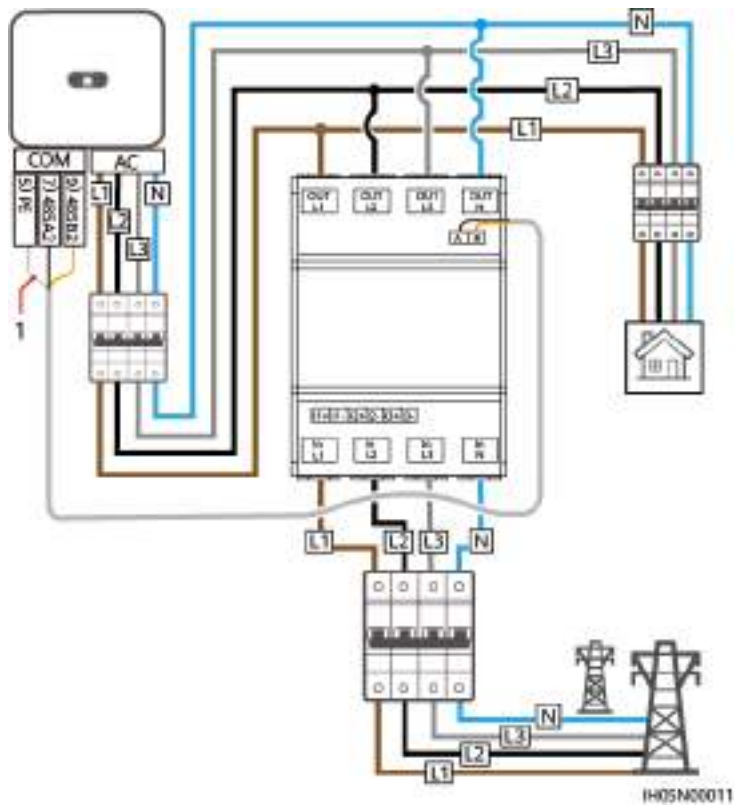

Figure 5-28 Three-phase, three-wire direct connection (SmartLogger networking)

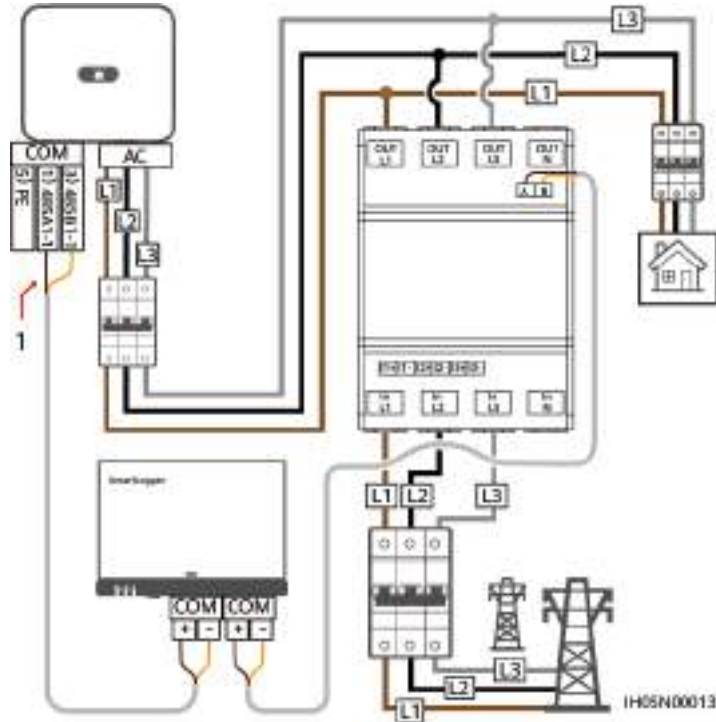
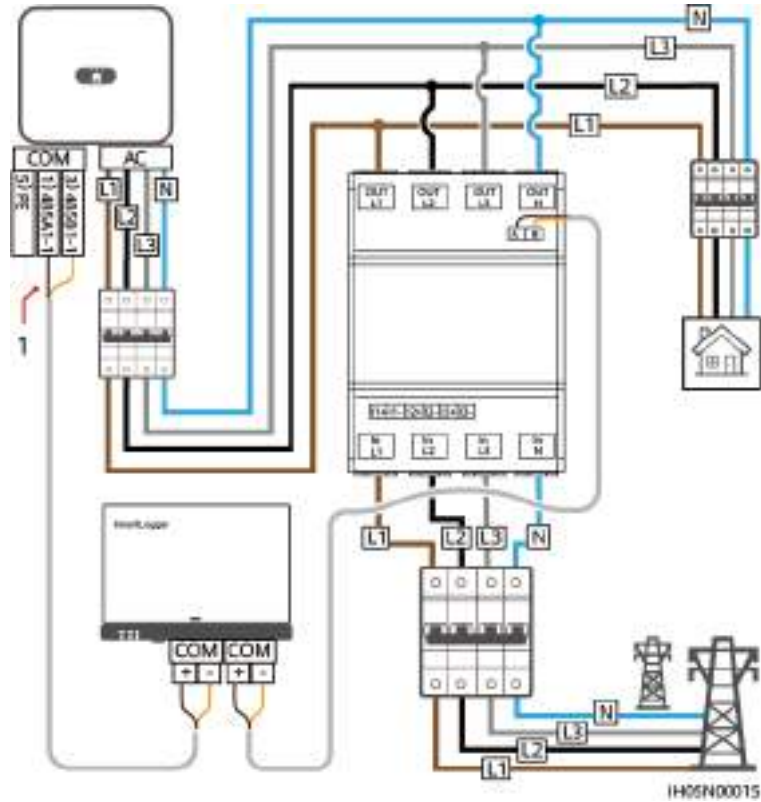

Figure 5-29 Three-phase, four-wire direct connection (SmartLogger networking)



(1) Shielding layer of the signal cable

NOTE

- The DTSU666-HW and YDS60-80 power meters support a maximum current of 80 A.
- If the SUN2000-(2KTL-6KTL)-L1 are cascaded with three-phase inverters, they must be connected to the grid in the same phase.
- For a three-phase three-wire system, you need to set the cable connection mode. Otherwise, the displayed voltage is incorrect.
- Ensure that the baud rates of the DTSU666-H, YDS60-C24, DTSU71 and DHSU1079-CT meters are set to the default values. If they are changed, meters may go offline, generate alarms, or affect the inverter output power.

Table 5-4 Select the cable connection mode

Parameter	Note
nEt	Select the cable connection mode: 0: n.34 indicates three-phase four-wire. 1: n.33 indicates three-phase three-wire.

Procedure

Step 1 Connect the signal cable to the signal cable connector.

Figure 5-30 Installing the cable

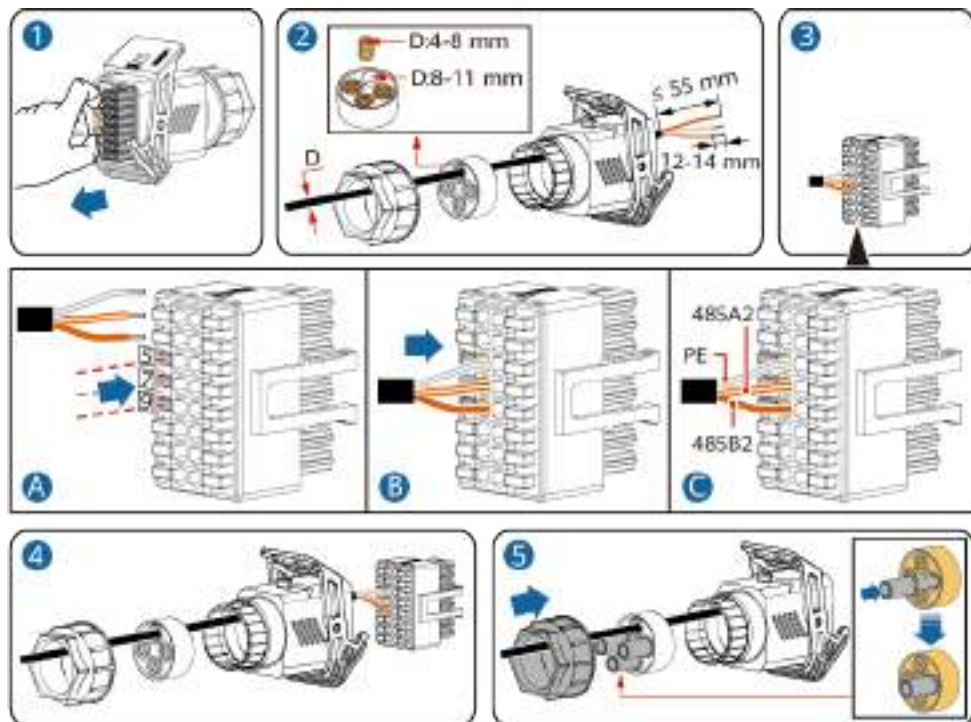

510420008

Step 2 Connect the signal cable to the COM port.

Figure 5-31 Securing the signal cable connector

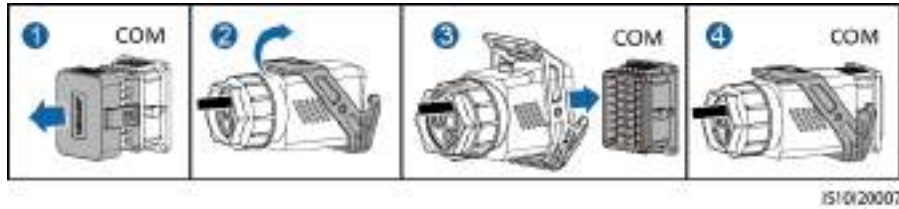

----End

5.8.3 Connecting an RS485 Communications Cable (Between a Power Meter and a Battery)

Procedure

Step 1 Connect the signal cable to the signal cable connector.

Figure 5-32 Installing the cable

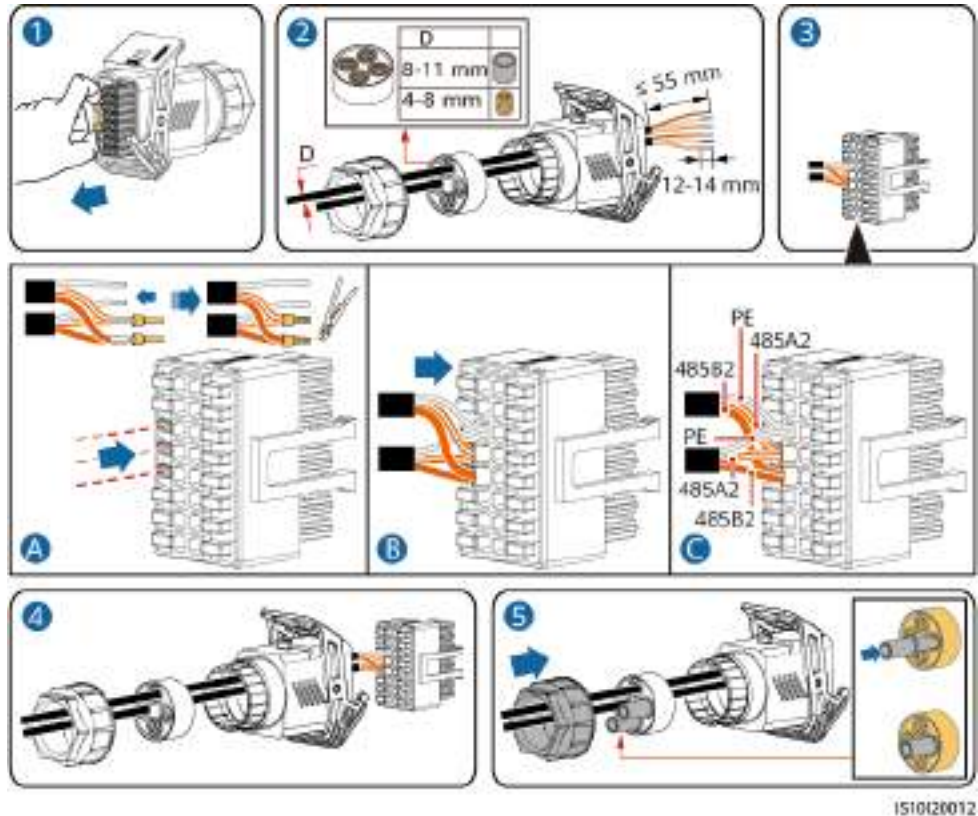

Step 2 Connect the signal cable connector to the COM port.

Figure 5-33 Securing the signal cable connector

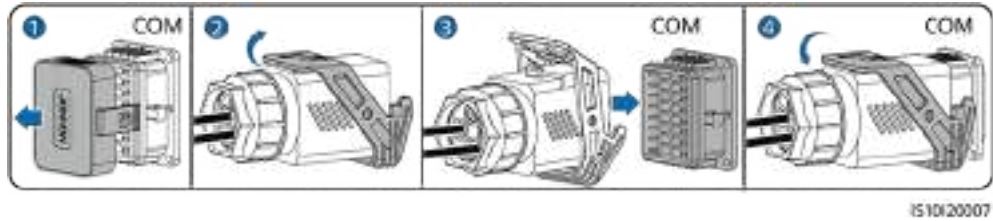

----End

5.8.4 Connecting the Power Grid Scheduling Signal Cable

Cable Connection

The following figure shows the cable connections between the inverter and the Ripple Control Device.

Figure 5-34 Cable connection

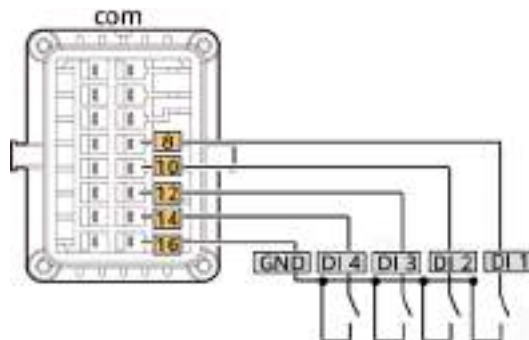

Procedure

Step 1 Connect the signal cable to the signal cable connector.

Figure 5-35 Installing the cable

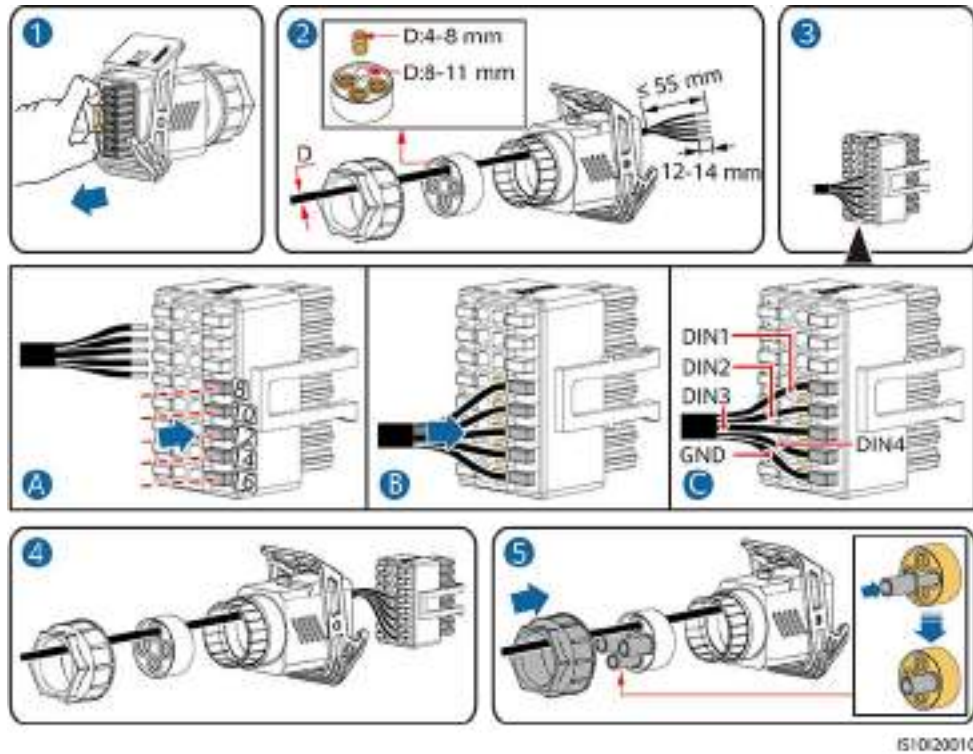

Step 2 Connect the signal cable to the COM port.

Figure 5-36 Securing the signal cable connector

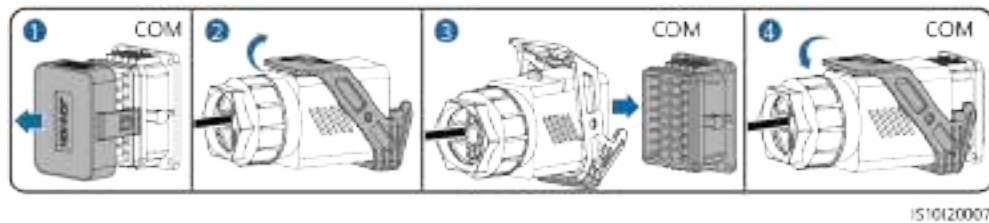

----End

5.8.5 Connecting a Signal Cable to the Smart Backup Box

Procedure

Step 1 Connect the signal cable to the signal cable connector.

Figure 5-37 Installing the cable

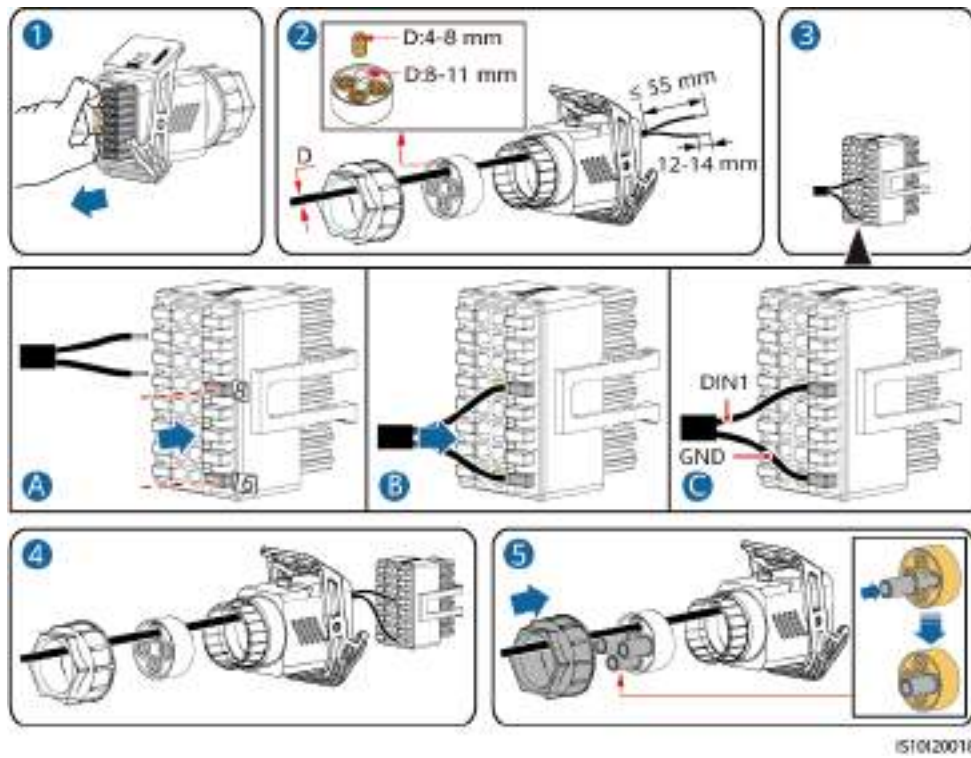

Step 2 Connect the signal cable connector to the COM port.

Figure 5-38 Securing the signal cable connector

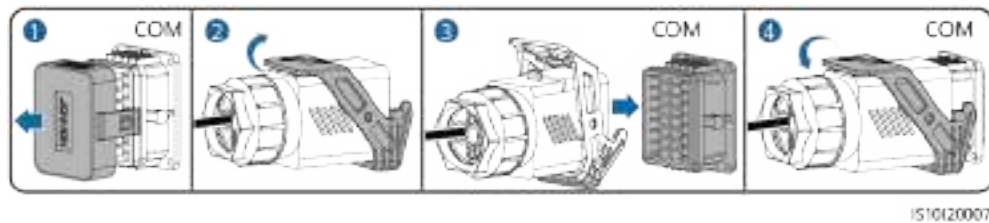

----End

5.8.6 Connecting the NS Protection Signal Cable

Connecting NS Protection Signal Cables to Inverters

 NOTE

- The NS protection function is applicable to grid code **VDE-AR-N-4105, SWITZERLAND-NA/EEA:2020-LV230, FINLAND-EN50549-LV230, or ANRE.**
- The NS protection switch is connected to GND (pin 13) at one end and to DIN5 (pin 15) at the other end. The switch is turned off by default. When the switch is turned on, NS protection is triggered. Rapid shutdown and NS protection use the same pins, which are GND (pin 13) and DIN5 (pin 15). Therefore, you can use only one of the functions.
- The NS protection switch connection is the same for a single inverter and for cascaded inverters.
- Log in to the FusionSolar app as an installer, choose **Me > Device commissioning**, and connect to the WLAN hotspot of the inverter. Log in to the local commissioning system as an installer, choose **Settings > Feature parameters > Dry contact function**, and set **Dry contact function** to **NS protection**.

Figure 5-39 Connecting cascaded inverters to the NS protection switch

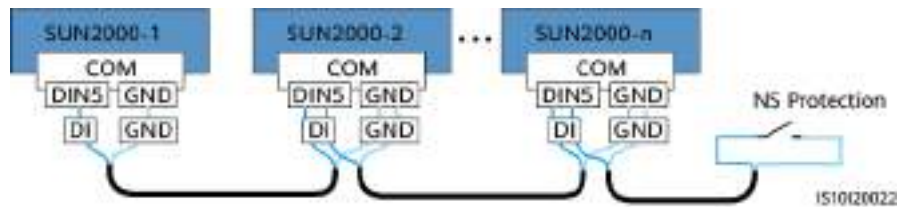

Step 1 Connect the signal cables of the cascaded inverters to the signal cable connectors.

Figure 5-40 Installing cables

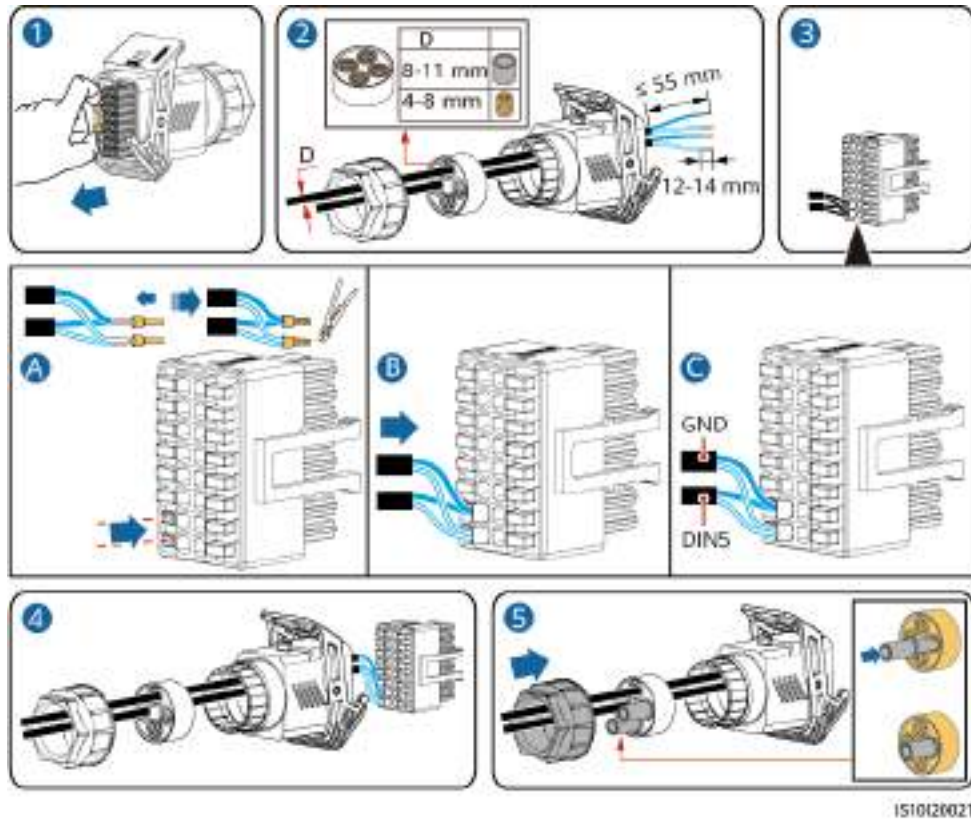

Step 2 Connect the signal cable connectors to the COM ports.

Figure 5-41 Securing the signal cable connector

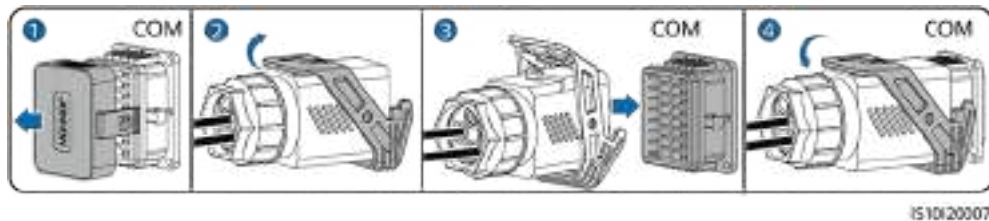

----End

Connecting NS Protection Signal Cables to the SmartLogger

NOTE

- The NS protection function is applicable to grid code **VDE-AR-N-4105**, **SWITZERLAND-NA/EEA:2020-LV230**, **FINLAND-EN50549-LV230**, or **ANRE**.
- The NS protection device is connected to the AI1 port and 12 V power output port on the SmartLogger. The SmartLogger shuts down the inverter over the voltage change detected at the AI1 port. When the NS protection device is disconnected, the AI1 port voltage is 0 V, and the inverter shuts down. When the NS protection device is connected again, the AI1 port voltage is 12 V, and you need to start the inverter manually.

Figure 5-42 Connecting the SmartLogger to the NS protection switch

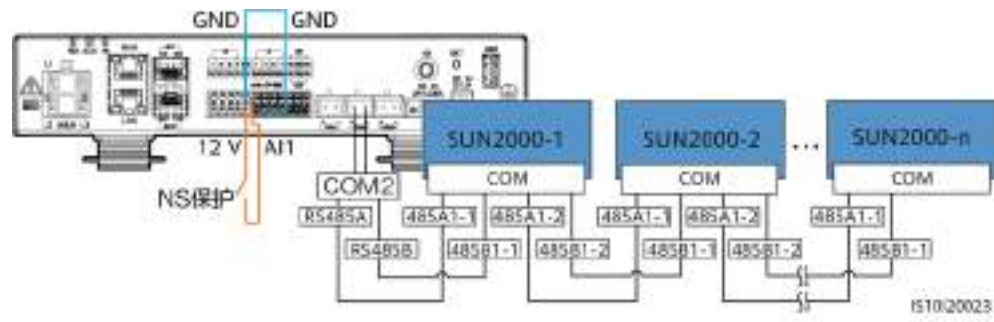

6 Commissioning

DANGER

- Wear personal protective equipment and use dedicated insulated tools to avoid electric shocks or short circuits.

NOTICE

Before the equipment is put into operation for the first time, ensure that the parameters are set correctly by professional personnel. Incorrect parameter settings may result in noncompliance with local grid connection requirements and affect the normal operations of the equipment.

[6.1 Checking Before Power-On](#)

[6.2 SUN2000 power-on](#)

6.1 Checking Before Power-On

Table 6-1 Checklist

No.	Item	Acceptance Criterion
1	SUN2000 installation	The SUN2000 is installed correctly and securely.
2	Smart Dongle	The Smart Dongle is installed correctly and securely.
3	Cable routing	The cables are routed properly as required by the customer.
4	Cable ties	Cable ties are secured evenly and no burr exists.

No.	Item	Acceptance Criterion
5	Reliable grounding	The PE cable is connected correctly and securely.
6	Switch	DC switches and all the switches connecting to the SUN2000 are OFF.
7	Cable connection	The AC output power cable, DC input power cables, battery cable, and signal cable are connected correctly and securely.
8	Unused terminals and ports	Unused terminals and ports are locked by watertight caps.
9	Installation environment	The installation space is proper, and the installation environment is clean and tidy.

6.2 SUN2000 power-on

Important Notes

NOTICE

Before the equipment is put into operation for the first time, ensure that the parameters are set correctly by professional personnel. Incorrect parameter settings may result in noncompliance with local grid connection requirements and affect the normal operations of the equipment.

NOTICE

Before turning on the AC switch between the SUN2000 and the power grid, check that the AC voltage is within the specified range using a multimeter.

Procedure

- Step 1** If a battery is connected, turn on the battery switch.
- Step 2** Turn on the AC switch between the SUN2000 and the power grid.

NOTICE

If the DC is on and the AC is off, the SUN2000 reports a **Grid Failure** alarm. The SUN2000 starts normally only after the fault is automatically rectified.

Step 3 (Optional) Remove the locking screw from the DC switch.

Figure 6-1 Removing the locking screw from a DC switch

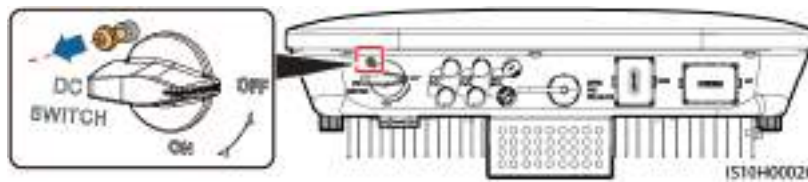



Step 4 Turn on the DC switch (if any) between the PV string and the SUN2000.

Step 5 Turn on the DC switch at the bottom of the SUN2000.

Step 6 Wait for about 1 minute and observe the LED indicators on the SUN2000 to check its running status.

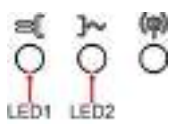
Table 6-2 LED indicator description

Category	Status		Meaning
Running indication 	LED1	LED2	N/A
	Steady green	Steady green	The SUN2000 is operating in grid-tied mode.
	Blinking green at long intervals (on for 1s and then off for 1s)	Off	The DC is on and the AC is off.
	Blinking green at long intervals (on for 1s and then off for 1s)	Blinking green at long intervals (on for 1s and then off for 1s)	The DC is on, the AC is on, and the SUN2000 is not exporting power to the power grid.
	Off	Blinking green at long intervals (on for 1s and then off for 1s)	The DC is off and the AC is on.
	Steady orange	Steady orange	The SUN2000 is operating in the off-grid mode.
	Blinking orange slowly	Off	The DC is on, and the SUN2000 has no output in the off-grid mode.
	Blinking orange slowly	Blinking orange slowly	The SUN2000 is operating in the overload in backup mode.
	Off	Off	Both the DC and AC are off.

Category	Status			Meaning
	Blinking red at short intervals (on for 0.2s and then off for 0.2s)	N/A		There is a DC environmental alarm, such as an alarm indicating that High String Input Voltage, String Reverse Connection, or Low Insulation Resistance.
	N/A	Blinking red at short intervals (on for 0.2s and then off for 0.2s)		There is an AC environmental alarm, such as an alarm indicating Grid Undervoltage, Grid Overvoltage, Grid Overfrequency, or Grid Underfrequency.
	Steady red	Steady red		Fault
Communication indication 	LED3			N/A
	Blinking green at short intervals (on for 0.2s and then off for 0.2s)			Communication is in progress. (When a mobile phone is connected to the SUN2000, the indicator first indicates that the phone is connected to the SUN2000): blinks green at long intervals.)
	Blinking green at long intervals (on for 1s and then off for 1s)			The mobile phone is connected to the SUN2000.
	Off			There is no communication.
Device replacement indication	LED1	LED2	LED3	N/A
	Steady red	Steady red	Steady red	The SUN2000 hardware is faulty. The SUN2000 needs to be replaced.

 **NOTE**

If the off-grid load is overloaded, indicators LED1 and LED2 on the inverter blink orange slowly. Reduce the off-grid load power and manually clear the alarm or until the inverter is recovered. The inverter attempts to restart at an interval of 5 minutes. If the inverter fails to restart for three times, the interval changes to 2 hours. If the inverter is standby in off-grid mode, check the inverter alarms and rectify the fault.

Step 7 (Optional) Observe the LED indicator on the Smart Dongle to check its running status.

- WLAN-FE Smart Dongle

Figure 6-2 WLAN-FE Smart Dongle

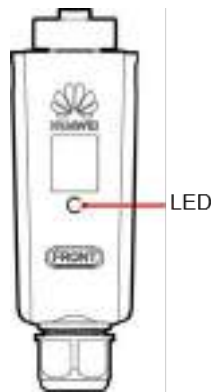

Table 6-3 Indicator description

Indicators	Status	Remarks	Description
-	Off	Normal	The Smart Dongle is not secured or not powered on.
Yellow (blinking green and red simultaneously)	Steady on		The Smart Dongle is secured and powered on.
Red	Blinking at short intervals (on for 0.2s and then off for 0.2s)		The parameters for connecting to the router are not set.
Red	Steady on	Abnormal	The Smart Dongle is faulty. Replace the Smart Dongle.
Blinking red and green alternatively	Blinking at long intervals (on for 1s and then off for 1s)	Abnormal	No communication with the SUN2000 <ul style="list-style-type: none"> - Remove and then insert the Smart Dongle. - Check whether the SUN2000 matches the Smart Dongle. - Connect the Smart Dongle to another SUN2000. Check whether the Smart Dongle is faulty or the USB port of the SUN2000 is faulty.

Indicators	Status	Remarks	Description
Green	Blinking at long intervals (on for 0.5s on and then off for 0.5s)	Normal	Connecting to the router.
Green	Steady on		Connected to the management system.
Green	Blinking at short intervals (on for 0.2s and then off for 0.2s)		The SUN2000 communicates with the management system through the Smart Dongle.

- 4G Smart Dongle

Table 6-4 Indicator description

Indicators	Status	Remarks	Description
-	Off	Normal	The Smart Dongle is not secured or not powered on.
Yellow (blinking green and red simultaneously)	Steady on	Normal	The Smart Dongle is secured and powered on.
Green	The blinking interval is 2s. The indicator is on for 0.1s and then off for 1.9s alternately.	Normal	Dialing (lasting for less than 1 minute)
		Abnormal	If the duration is longer than 1 minute, the 4G parameter settings are incorrect. Reset the parameters.
	Blinking at long intervals (on for 1s and then off for 1s)	Normal	The dialup is successful (lasting for less than 30s).
		Abnormal	If the duration is longer than 30s, the management system parameters are incorrectly set. Reset the parameters.
Steady on	Normal	Connected to the management system.	

Indicators	Status	Remarks	Description
	Blinking at short intervals (on for 0.2s and then off for 0.2s)		The SUN2000 communicates with the management system through the Smart Dongle.
Red	Steady on	Abnormal	The Smart Dongle is faulty. Replace the Smart Dongle.
	Blinking at short intervals (on for 0.2s and then off for 0.2s)		The Smart Dongle has no SIM card or the SIM card is in poor contact. Check whether the SIM card has been installed or is in good contact. If not, install the SIM card or remove and insert the SIM card.
	Blinking at long intervals (on for 1s and then off for 1s)		The Smart Dongle fails to be connected to a management system because the SIM card has no signals, weak signal strength, or no traffic. If the Smart Dongle is reliably connected, check the SIM card signal through the SUN2000 app. If no signal is received or the signal strength is weak, contact the carrier. Check whether the tariff and traffic of the SIM card are normal. If not, recharge the SIM card or buy traffic.

Indicators	Status	Remarks	Description
Blinking red and green alternatively	Blinking at long intervals (on for 1s and then off for 1s)		No communication with the SUN2000 <ul style="list-style-type: none">- Remove and then insert the Smart Dongle.- Check whether the SUN2000 matches the Smart Dongle.- Connect the Smart Dongle to another SUN2000. Check whether the Smart Dongle is faulty or the USB port of the SUN2000 is faulty.

----End

7 Man-Machine Interaction

[7.1 App Commissioning](#)

[7.2 Parameters Settings](#)

[7.3 SmartLogger Networking Scenario](#)

7.1 App Commissioning

7.1.1 Downloading the FusionSolar App

- Method 1: Access <https://solar.huawei.com> using the mobile phone browser and download the latest installation package.

Figure 7-1 Download Mode



- Method 2: Search for FusionSolar on Huawei AppGallery and download the latest installation package.
- Method 3: Scan the following QR code and download the latest installation package.

Figure 7-2 QR code



7.1.2 (Optional) Registering an Installer Account

NOTE

- If you have an installer account, skip this step.
- You can register an account only using a mobile phone only in China.
- The mobile number or email address used for registration is the user name for logging in to the FusionSolar App.

Create the first installer account and create a domain named after the company name.

Figure 7-3 Creating the first installer account

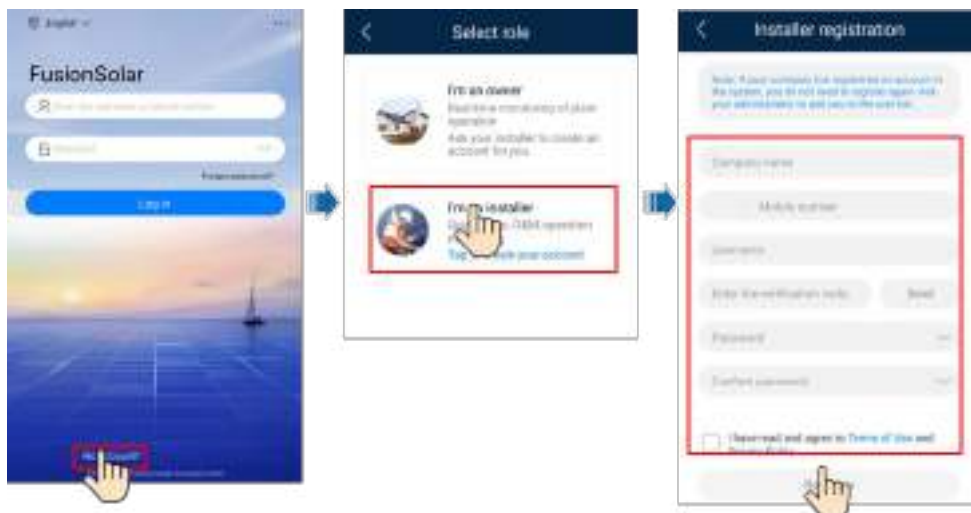

NOTICE

To create multiple installer accounts for a company, log in to the FusionSolar App and tap **Add User** to create an installer account.

Figure 7-4 Creating multiple installer accounts for the same company

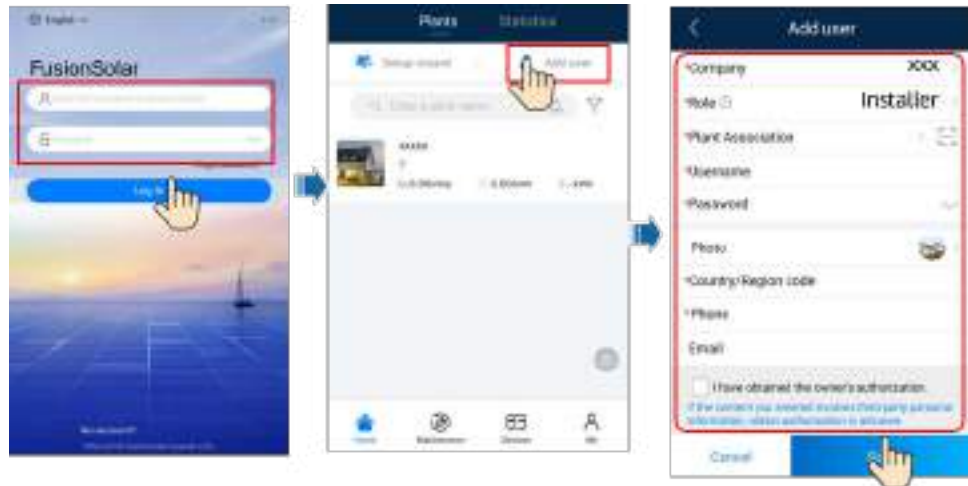

7.1.3 Creating a PV Plant and a User

Figure 7-5 Creating a PV plant and a user



NOTE

- In the quick settings, the grid code is set to N/A by default (automatic startup is not supported). Set the grid code based on the area where the PV plant is located.
- For details about how to use the site deployment wizard, see [FusionSolar App Quick Guide](#). You can scan the QR code to download the quick guide.



7.1.4 (Optional) Setting the Physical Layout of the Smart PV Optimizers

 NOTE

- If smart PV optimizers are configured for PV strings, ensure that the smart PV optimizers have been successfully connected to the inverter before performing the operations in this section.
- Check that the SN labels of smart PV optimizers are correctly attached to the physical layout template.
- Take and save a photo of the physical layout template. Keep your phone parallel to the template and take a photo in landscape mode. Ensure that the four positioning points in the corners are in the frame. Ensure that each QR code is attached within the frame.
- For details about the physical layout of smart PV optimizers, see [FusionSolar App Quick Guide](#). You can scan the QR code to download the quick guide.



Scenario 1: Setting on the FusionSolar Server Side (Solar Inverter Connected to the Management System)

Step 1 Log in to the FusionSolar App and tap the plant name on the **Home** screen to access the plant screen. Select **Layout**, tap , and upload the physical layout template photo as prompted.

Figure 7-6 Uploading the physical layout template photo (App)



 NOTE

You can also upload the physical layout template photo on the WebUI as follows: Log in to <https://intl.fusionsolar.huawei.com> to access the WebUI of the FusionSolar Smart PV Management System. On the **Home** page, click the plant name to go to the plant page. Choose **Layout**, click **Click to Upload**, and upload the physical layout template photo.

Figure 7-7 Uploading the physical layout template photo (WebUI)

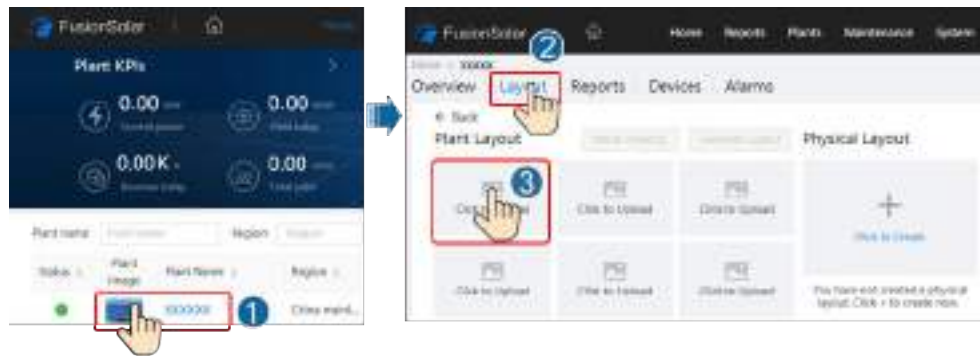

Step 2 Log in to <https://intl.fusionsolar.huawei.com> to access the WebUI of the FusionSolar Smart PV Management System. On the **Home** page, click the plant name to go to the plant page. Select **Layout**. Choose **Generate layout**, and create a physical layout as prompted. You can also manually create a physical location layout.

Figure 7-8 Physical layout design of PV modules

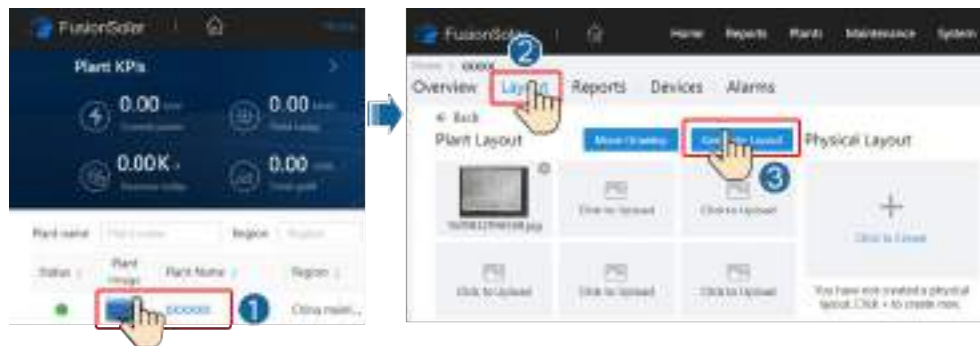

----End

Scenario 2: Setting on the Solar Inverter Side (Solar Inverter Not Connected to the Management System)

Step 1 Access the **Device Commissioning** screen on the FusionSolar App to set the physical layout of Smart PV Optimizers.

1. Log in to the FusionSolar App. On the **Device Commissioning** screen, choose **Maintenance > Optimizer layout**. The **Optimizer layout** screen is displayed.
2. Tap the blank area. The **Identify image** and **Add PV modules** buttons are displayed. You can use either of the following methods to perform operations as prompted:
 - Method 1: Tap **Identify image** and upload the physical layout template photo to complete the optimizer layout. (The optimizers that fail to be identified need to be manually bound.)
 - Method 2: Tap **Add PV modules** to manually add PV modules and bind the optimizers to the PV modules.

Figure 7-9 Physical layout design of PV modules

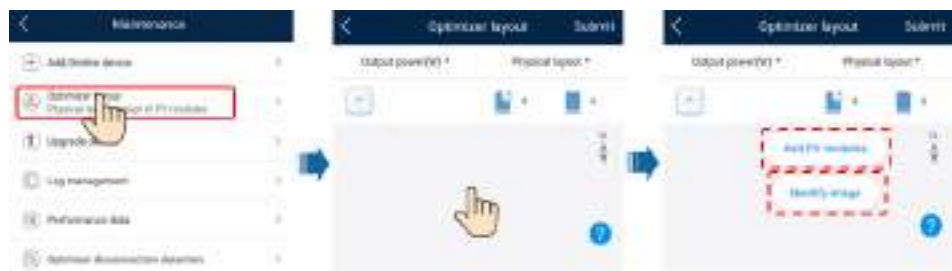

----End

7.1.5 Detecting Optimizer Disconnection

Log in to the FusionSolar app, choose **Device Commissioning > Maintenance > Optimizer disconnection detection**, tap the detection button to detect the optimizer disconnection, and rectify the fault based on the detection result.

Figure 7-10 Detect optimizer disconnection

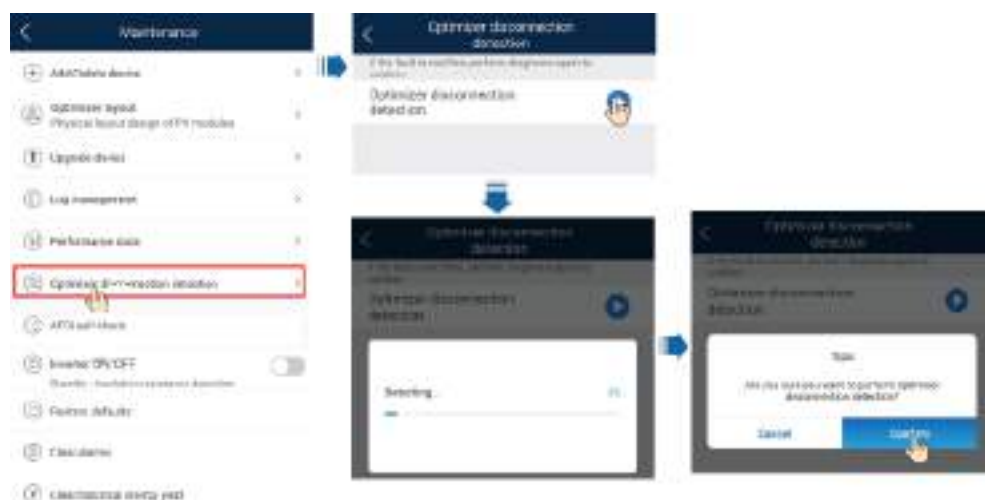

7.2 Parameters Settings

Go to the **Device Commissioning** screen and set inverter parameters. For details about entering the **Device Commissioning** screen, see [B Device Commissioning](#).

To set more parameters, tap **Settings**. For details about the parameters, see the [FusionSolar App and SUN2000 App User Manual](#). You can also scan the QR code to obtain the document.



7.2.1 Energy Control

7.2.1.1 Grid-tied Point Control

Function

The output power of the PV power system can be limited or reduced to ensure that the output power is within the specified range.

Procedure

On the home screen, choose **Power adjustment > Grid-tied point control**.

Figure 7-11 Grid-tied point control



Table 7-1 Grid-tied point control

Parameter			Description
Active power	Unlimited	-	If this parameter is set to Unlimited , the output power of the inverter is not limited and the inverter can connect to the power grid at the rated power.
	Grid connected with zero power	Closed-loop controller	<ul style="list-style-type: none"> If multiple inverters are cascaded, set this parameter to SDongle/SmartLogger. If there is only one inverter, set this parameter to Inverter.
		Limitation mode	Total power indicates export limitation of the total power at the grid-tied point. (When a single-phase power meter is connected, only Total power can be selected.)
		Power adjustment interval	Specifies the shortest interval for a single export limitation adjustment.
		Power control hysteresis	Specifies the deadband for adjusting the inverter output power. If the power fluctuates within the power control hysteresis, the power is not adjusted.

Parameter		Description	
	Active power output limit for fail-safe	Specifies the derating value of the inverter active power by percentage. If the Smart Dongle does not detect any power meter data or the communication between the Smart Dongle and the inverter is disconnected, the Smart Dongle delivers the derating value of the inverter active power by percentage.	
	Communication disconnection fail-safe	In the inverter export limitation scenario, if this parameter is set to Enable , the inverter will derate according to the active power derating percentage when the communication between the inverter and the Smart Dongle is disconnected for a period longer than Communication disconnection detection time .	
	Communication disconnection detection time	Specifies the fail-safe detection time in case of disconnection between the inverter and the Smart Dongle. This parameter is displayed when Communication disconnection fail-safe is set to Enable .	
	Limited feed-in (kW)	Closed-loop controller	<ul style="list-style-type: none"> If multiple inverters are cascaded, set this parameter to SDongle/SmartLogger. If there is only one inverter, set this parameter to Inverter.
		Limitation mode	Total power indicates export limitation of the total power at the grid-tied point. (When a single-phase power meter is connected, only Total power can be selected.)
		Maximum grid feed-in power	Specifies the maximum active power transmitted from the grid-tied point to the power grid.
		Power adjustment interval	Specifies the shortest interval for a single export limitation adjustment.
		Power control hysteresis	Specifies the deadband for adjusting the inverter output power. If the power fluctuates within the power control hysteresis, the power is not adjusted.
		Active power output limit for fail-safe	Specifies the derating value of the inverter active power by percentage. If the Smart Dongle does not detect any power meter data or the communication between the Smart Dongle and the inverter is disconnected, the Smart Dongle delivers the derating value of the inverter active power by percentage.
		Communication disconnection fail-safe	In the inverter export limitation scenario, if this parameter is set to Enable , the inverter will derate according to the active power derating percentage when the communication between the inverter and the Smart Dongle is disconnected for a period longer than Communication disconnection detection time .

Parameter		Description
	Communication disconnection detection time	Specifies the fail-safe detection time in case of disconnection between the inverter and the Smart Dongle. This parameter is displayed when Communication disconnection fail-safe is set to Enable .
Power-limited grid connected (%)	Closed-loop controller	<ul style="list-style-type: none"> If multiple inverters are cascaded, set this parameter to SDongle/SmartLogger. If there is only one inverter, set this parameter to Inverter.
	Limitation mode	Total power indicates export limitation of the total power at the grid-tied point. (When a single-phase power meter is connected, only Total power can be selected.)
	PV plant capacity	Specifies the total maximum active power in the inverter cascading scenario.
	Maximum grid feed-in power	Specifies the percentage of the maximum active power of the grid-tied point to the PV plant capacity.
	Power adjustment interval	Specifies the shortest interval for a single export limitation adjustment.
	Power control hysteresis	Specifies the deadband for adjusting the inverter output power. If the power fluctuates within the power control hysteresis, the power is not adjusted.
	Active power output limit for fail-safe	Specifies the derating value of the inverter active power by percentage. If the Smart Dongle does not detect any power meter data or the communication between the Smart Dongle and the inverter is disconnected, the Smart Dongle delivers the derating value of the inverter active power by percentage.
	Communication disconnection fail-safe	In the inverter export limitation scenario, if this parameter is set to Enable , the inverter will derate according to the active power derating percentage when the communication between the inverter and the Smart Dongle is disconnected for a period longer than Communication disconnection detection time .
	Communication disconnection detection time	Specifies the fail-safe detection time in case of disconnection between the inverter and the Smart Dongle. This parameter is displayed when Communication disconnection fail-safe is set to Enable .
Shutdown at high feed-in power ^a	<ul style="list-style-type: none"> The default value is Disable. If this parameter is set to Enable, the inverter shuts down for protection when the power at the grid-tied point exceeds the threshold and remains in this condition for the specified time threshold. 	

Parameter		Description
	Upper feed-in power threshold for inverter shutdown (kW)	The default value is 0 . This parameter specifies the power threshold of the grid-tied point for triggering inverter shutdown.
	High feed-in power duration threshold for triggering inverter shutdown (s)	<p>The default value is 20. This parameter specifies the duration threshold of high feed-in power for triggering inverter shutdown.</p> <ul style="list-style-type: none"> When High feed-in power duration threshold for triggering inverter shutdown is set to 5, Shutdown at high feed-in power takes precedence. When High feed-in power duration threshold for triggering inverter shutdown is set to 20, Grid connection with limited power takes precedence (when Active power control is set to Grid connection with limited power).
<p>Note a: This parameter is supported only for the AS4777 or G99-TYPEA-LV grid code.</p>		

7.2.1.2 Apparent Power Control on the Inverter Output Side

On the home screen, tap **Settings > Power adjustment** to set inverter parameters.

Figure 7-12 Apparent power control

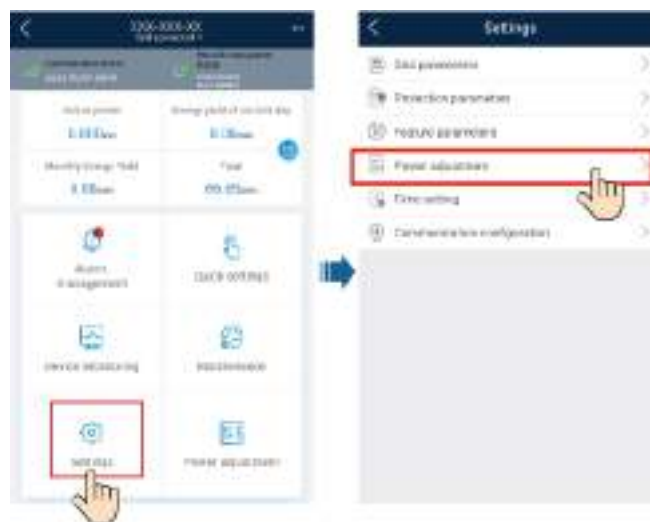

Table 7-2 Apparent power

Parameter	Description	Value Range
Maximum apparent power (kVA)	Specifies the output upper threshold for the maximum apparent power to adapt to the capacity requirements of standard and customized inverters.	[Maximum active power, S_{max}]
Maximum active power (kW)	Specifies the output upper threshold for the maximum active power to adapt to different market requirements.	[0.1, P_{max}]

NOTE

The lower threshold for the maximum apparent power is the maximum active power. To lower the maximum apparent power, lower the maximum active power first.

7.2.1.3 Battery Control

Prerequisites

The screenshots in this section correspond to the SUN2000 app 3.2.00.011. The app is being updated. The actual UI may vary.

Function

When the inverter connects to a battery, add the battery and set battery parameters.

Adding a Battery

To add a battery, choose **Maintenance > Subdevice management** on the home screen.

Figure 7-13 Adding a battery



Parameter Settings

On the home screen, choose **Power adjustment** > **Battery control**, and set the battery control parameters and working mode.

Figure 7-14 Battery control parameter setting

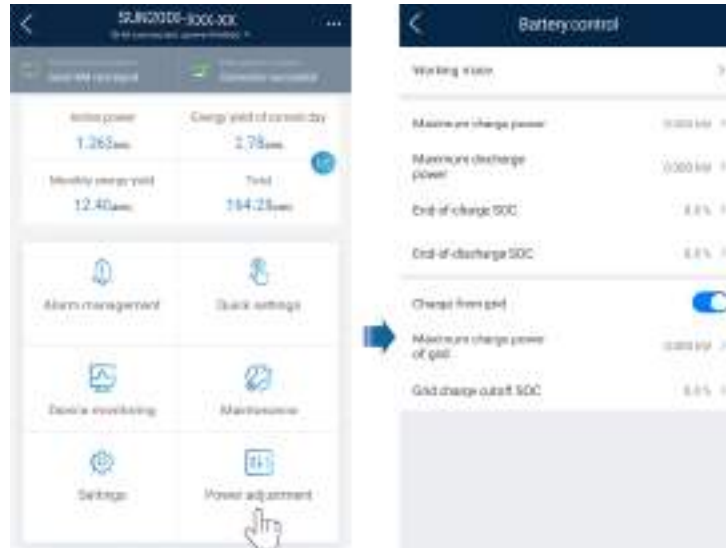

Parameter	Description	Value Range
Working mode	For details, see the description on the app.	<ul style="list-style-type: none"> Maximum self-consumption TOU Fully fed to grid
Maximum charge power (kW)	Charge power of the power control module. Retain this parameter to the maximum charge power. Additional configuration is not required.	<ul style="list-style-type: none"> Charge: [0, Maximum charge power]
Maximum discharge power (kW)	Discharge power of the power control module. Retain this parameter to the maximum discharge power. Additional configuration is not required.	<ul style="list-style-type: none"> Discharge: [0, Maximum discharge power]
End-of-charge SOC (%)	Set the end-of-charge SOC.	90%–100%
End-of-discharge SOC (%)	Set the end-of-discharge SOC.	0%–20% (If no PV module is configured or PV modules have no voltage for 24 hours, set this parameter to a minimum of 15%.)

Parameter	Description	Value Range
Charge from grid	If Charge from grid is disabled by default, comply with the grid charge requirements stipulated in local laws and regulations when this function is enabled.	<ul style="list-style-type: none"> • Disable • Enable
Grid charge cutoff SOC	Set the cutoff SOC for charge from the grid.	[20%, 100%]

7.2.1.4 Peak Shaving

Prerequisites

The app is being updated. The actual UI may vary.

Function

If the inverter connects to an ESS and the ESS working mode is set to **Maximum self-consumption** or **TOU**, you can set peak shaving parameters.

Table 7-3 Application scenario

Model	Application Scenario
SUN2000-(5KTL-12 KTL)-M1 series	Single inverter + Smart Dongle (WLAN-FE) + LUNA2000 connected to the management system

Parameter Settings

On the home screen, choose **Power adjustment > Peak shaving** and set peak shaving parameters.

NOTE

- The peak shaving function is unavailable when the ESS working mode is set to **Fully fed to grid**.
- If you need to set **Fully fed to grid** but the peak shaving function has been enabled, first disable peak shaving and then set the ESS working mode to **Fully fed to grid**.

Figure 7-15 Setting peak shaving parameters

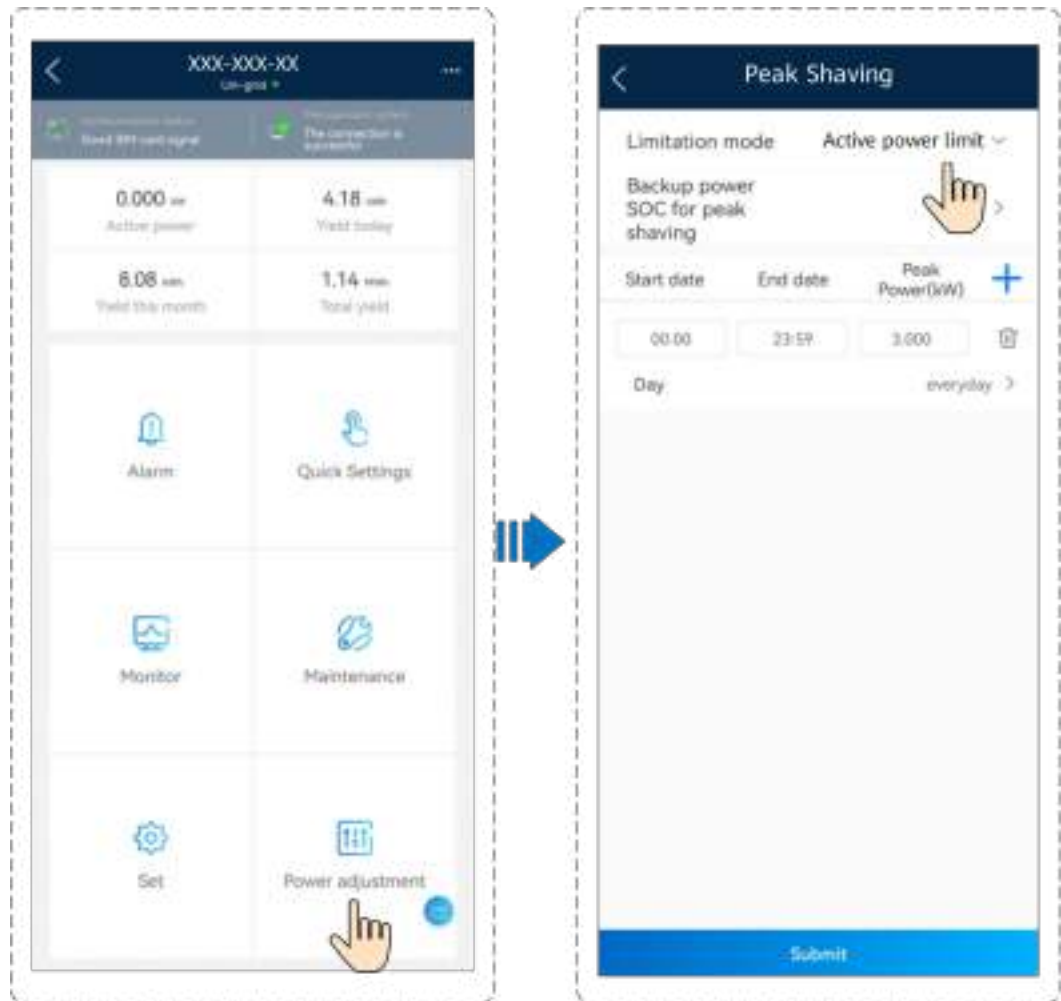

Parameter	Description	Value Range
Peak shaving	<ol style="list-style-type: none"> Before enabling Peak shaving, enable Charge from grid. Before disabling Charge from grid, disable Peak shaving. 	<ul style="list-style-type: none"> Disable Active capacity limit
Backup power SOC for peak shaving (%)	The value of this parameter affects the peak shaving capability. A larger value indicates stronger peak shaving capability.	[0.0, 100.0] Backup power SOC for peak shaving > Backup power SOC (when BackUp is enabled) > End-of-discharge SOC

Parameter	Description	Value Range
Start date	<ul style="list-style-type: none"> Set the peak power range based on the start time and end time. The peak power is configured based on electricity prices in different time segments. You are advised to set the peak power to a low value when the electricity price is high. A maximum of 14 time segments can be set. 	-
End date		
Peak Power (kW)		[0.000, 1000.000]

Function

In SmartLogger networking, if the ESS working mode is **Maximum self-consumption** or **TOU**, you can set **Peak shaving** parameters on the SmartLogger WebUI or on the FusionSolar app after connecting the app to the SmartLogger by scanning the QR code.

Table 7-4 Application scenario

Model	Application Scenario
SUN2000-(5KTL-12KTL)-M1 series	SmartLogger + single inverter/cascaded inverters + LUNA2000 connected to the management system

Parameter Settings

- On the SmartLogger WebUI, choose **Settings > Battery control**, and set **Peak shaving**.
- Connect the app to the SmartLogger by scanning the QR code, choose **Power adjustment > Peak shaving**, and set related parameters.

NOTE

- In SmartLogger V300R023C00SPC170 or later, **Peak shaving** is displayed only when the export+import meter is connected in the ESS scenario.
- The peak shaving function is unavailable when the ESS working mode is set to **Fully fed to grid**.
- If you need to set **Fully fed to grid** but the peak shaving function has been enabled, first disable peak shaving and then set the ESS working mode to **Fully fed to grid**.
- For details about the peak shaving function, see [Introduction to Peak Shaving](#).

7.2.2 AFCI

Function

If PV modules or cables are not properly connected or damaged, electric arcs may occur, which may cause fire. Huawei inverters provide unique arc detection in compliance with UL 1699B-2018 to ensure the safety of users' lives and property.

This function is enabled by default. The inverter automatically detects arc faults. To disable this function, log in to the FusionSolar App, enter the **Device Commissioning** screen, choose **Settings > Feature parameters**, and disable **AFCI**.

 **NOTE**

The AFCI function works only with Huawei optimizers or ordinary PV modules, but does not support third-party optimizers or intelligent PV modules.

Clearing Alarms

The AFCI function involves the **DC arc fault** alarm.

The inverter has the AFCI alarm automatic clearance mechanism. If an alarm is triggered for less than five times within 24 hours, the inverter automatically clears the alarm. If the alarm is triggered for five times or more within 24 hours, the inverter locks for protection. You need to manually clear the alarm on the inverter so that it can work properly.

You can manually clear the alarm as follows:

- **Method 1:** FusionSolar App
Log in to the FusionSolar App and choose **Me > Device commissioning**. On the **Device commissioning** screen, connect and log in to the inverter that generates the AFCI alarm, tap **Alarm management**, and tap **Clear** on the right of the **DC arc fault** alarm to clear the alarm.

Figure 7-16 Alarm management

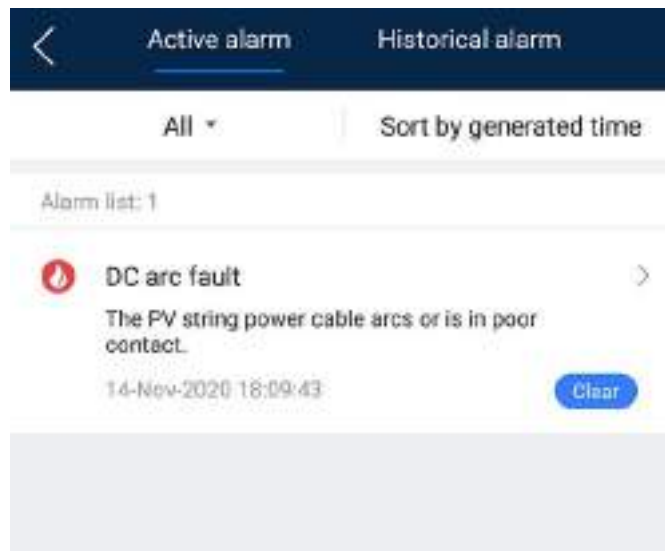

- **Method 2:** FusionSolar Smart PV Management System
Log in to the FusionSolar Smart PV Management System using a non-owner account, choose **Maintenance > Alarm Management**, select the **DC arc fault** alarm, and click **Clear** to clear the alarm.

Figure 7-17 Clearing alarms



Switch to the owner account with PV plant management rights. On the home page, click the PV plant name to go to the PV plant page, and click **OK** as prompted to clear the alarm.

7.2.3 IPS Check (for Italy CEI0-21 Grid Code Only)

Function

The Italy CEI0-21 grid code requires an IPS check for the inverter. During the self-check, the inverter checks the protection threshold and protection time of the maximum voltage over 10 min (59.S1), maximum overvoltage (59.S2), minimum undervoltage (27.S1), minimum undervoltage (27.S2), maximum overfrequency (81.S1), maximum overfrequency (81.S2), minimum underfrequency (81.S), and minimum underfrequency (81.S2).

Procedure

- Step 1** On the home screen, choose **Maintenance > IPS test** to access the IPS test screen.
- Step 2** Tap **Start** to start an IPS test. The inverter detects maximum voltage over 10 min (59.S1), maximum overvoltage (59.S2), minimum undervoltage (27.S1), minimum undervoltage (27.S2), maximum overfrequency (81.S1), maximum overfrequency (81.S2), and minimum underfrequency (81.S1), and minimum underfrequency (81.S2).

Figure 7-18 IPS test

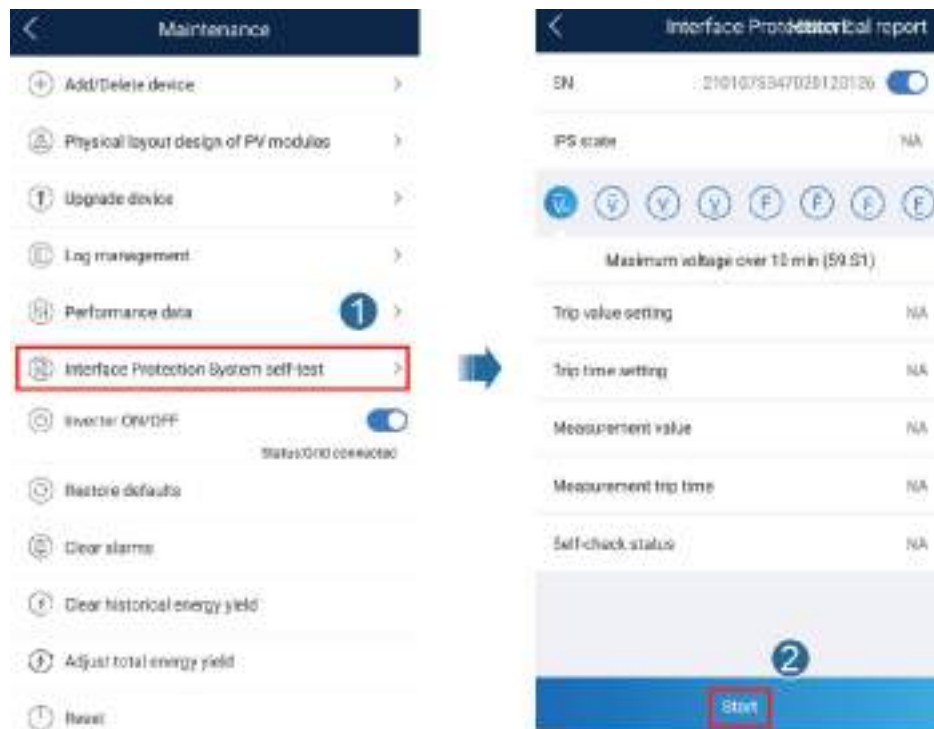

Table 7-5 IPS test type

IPS Test Type	Description
Maximum voltage over 10 min (59.S1)	The default maximum voltage over 10 min protection threshold is 253 V (1.10 Vn), and the default protection time threshold is 3s.
Maximum overvoltage (59.S2)	The default overvoltage protection threshold is 264.5 V (1.15 Vn), and the default protection time threshold is 0.2s.
Minimum undervoltage (27.S1)	The default undervoltage protection threshold is 195.5 V (0.85 Vn), and the default protection time threshold is 1.5s.
Minimum undervoltage (27.S2)	The default undervoltage protection threshold is 34.5 V (0.15 Vn), and the default protection time threshold is 0.2s.
Maximum overfrequency (81.S1)	The default overfrequency protection threshold is 50.2 Hz, and the default protection time threshold is 0.1s.
Maximum overfrequency (81.S2)	The default overfrequency protection threshold is 51.5 Hz, and the default protection time threshold is 0.1s.

IPS Test Type	Description
Minimum underfrequency (81.S1)	The default underfrequency protection threshold is 49.8 Hz, and the default protection time threshold is 0.1s.
Minimum underfrequency (81.S2)	The default underfrequency protection threshold is 47.5 Hz, and the default protection time threshold is 0.1s.

Step 3 After the IPS test is complete, **IPS State** is displayed as **IPS state success**. Tap **Historical report** in the upper right corner of the screen to view the IPS check report.

----End

7.2.4 DRM (Australia AS4777)

Function

According to Australia standards, inverters need to support the function of demand response modes (DRM), and DRM0 is a mandatory requirement.

This function is disabled by default.

Figure 7-19 Wiring diagram for the DRM function

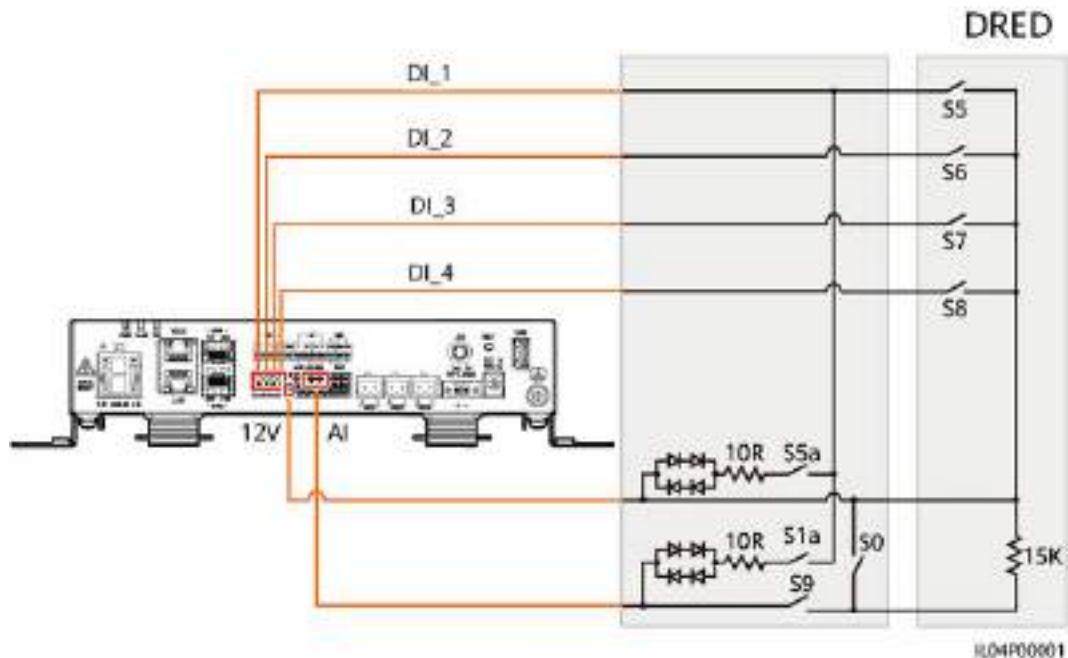

 **NOTE**

- The Demand Response Enabling Device (DRED) is a power grid dispatching device.
- Inverters need to connect to the SmartLogger to implement the DRM function.
- When the master inverter connects to the DRED through SmartLogger, log in to the SmartLogger WebUI and choose **Settings > DRM** and set DRM parameters. Alternatively, scan the QR code on the SmartLogger, log in to the FusionSolar app, choose **Power Adjustment > DRM** on the home screen, and set **DRM0 Access Port**.

Table 7-6 DRM requirements

Mode	SmartLogger Port	Requirement
DRM0	AI2-AI4	<ul style="list-style-type: none">• When S0 is turned on, the inverters shut down.• When S0 is turned off, the inverters are connected to the power grid.

Setting DRM on the FusionSolar SmartPVMS

Step 1 Log in to the FusionSolar SmartPVMS and select a PV plant on the home page.

Step 2 Choose **Device**, select the SmartLogger connected to the inverters, choose **Parameter settings > DRM**, and set **DRM0 Access Port**.

----End

7.3 SmartLogger Networking Scenario

See the [PV Plants Connecting to Huawei Hosting Cloud Quick Guide \(Inverters + SmartLogger3000 + RS485 Networking\)](#). You can scan the QR code to obtain it.

Figure 7-20 SmartLogger3000



8 Maintenance

Prerequisites

 **DANGER**

- Wear personal protective equipment and use dedicated insulated tools to avoid electric shocks or short circuits.
-

 **WARNING**

- Before performing maintenance, power off the equipment, follow the instructions on the delayed discharge label, and wait for a period of time as specified to ensure that the equipment is not energized.
-

[8.1 SUN2000 Power-Off](#)

[8.2 Routine Maintenance](#)

[8.3 Troubleshooting](#)

8.1 SUN2000 Power-Off

Important Notes

 **WARNING**

- After the system is powered off, the inverter is still energized and hot, which may cause electric shocks or burns. Therefore, wait for 5 minutes after power-off and then put on insulated gloves to operate the inverter.
 - Before maintaining the optimizer and PV string, turn off the AC switch and DC switch. Otherwise, electric shocks may occur as the PV string is energized.
-

Procedure

- Step 1** Turn off the AC switch between the SUN2000 and the power grid.
- Step 2** Turn off the DC switch at the bottom of the SUN2000.
- Step 3** (Optional) Install the locking screw beside the DC switch.

Figure 8-1 Installing the locking screw for the DC switch

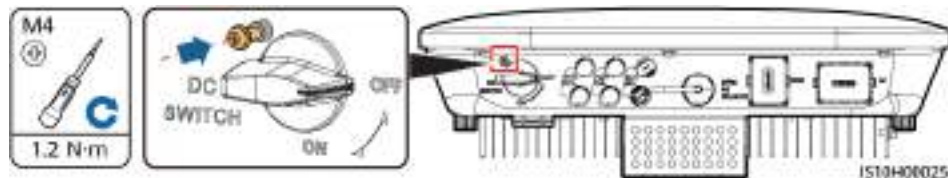

- Step 4** If there is a DC switch between the inverter and PV string, turn off the DC switch.
- Step 5** (Optional) Turn off the battery switch between the SUN2000 and batteries.

----End

8.2 Routine Maintenance

To ensure that the SUN2000 can operate properly for a long term, you are advised to perform routine maintenance on it as described in this chapter.

CAUTION

Before cleaning the system, connecting cables, and maintaining the grounding reliability, power off the system.

Table 8-1 Maintenance list

Check Detail	Check Method	Maintenance Interval
System cleanliness	Check the heat sink for foreign matter or the overall health of the SUN2000.	Annual or every time an abnormality is detected
System running status	Check the SUN2000 for damage or deformation.	Annual
Electrical connections	<ul style="list-style-type: none"> • Cables are securely connected. • Cables are intact, in particular, the parts touching the metallic surface are not scratched. 	The first inspection is 6 months after the initial commissioning. From then on, the interval can be 6 to 12 months.
Grounding reliability	Check whether the ground terminal and ground cable are securely connected.	Annual
Sealing	Check whether all terminals and ports are properly sealed.	Annual

8.3 Troubleshooting

For details about alarms, see the [Inverter Alarm Reference](#).

9 Handling the Inverter

[9.1 Removing the SUN2000](#)

[9.2 Packing the SUN2000](#)

[9.3 Disposing of the SUN2000](#)

9.1 Removing the SUN2000

NOTICE

Before removing the SUN2000, power off the AC and DC (batteries).

Perform the following operations to remove the SUN2000:

1. Disconnect all cables from the SUN2000, including RS485 communications cables, DC input power cables, AC output power cables, and PGND cables.
2. Remove the SUN2000 from the mounting bracket.
3. Remove the mounting bracket.

9.2 Packing the SUN2000

- If the original packing materials are available, put the SUN2000 inside them and then seal them by using adhesive tape.
- If the original packing materials are not available, put the SUN2000 inside a suitable cardboard box and seal it properly.

9.3 Disposing of the SUN2000

If the SUN2000 service life expires, dispose of it according to the local disposal rules for electrical equipment waste.

10 Technical Specifications

[10.1 SUN2000 Technical Specifications](#)

[10.2 Optimizer Technical Specifications](#)

10.1 SUN2000 Technical Specifications

Efficiency

Technical Specifications	SUN2000-3KTL-M1	SUN2000-4KTL-M1	SUN2000-5KTL-M1	SUN2000-6KTL-M1	SUN2000-8KTL-M1	SUN2000-10KTL-M1	SUN2000-10KTL-BEM1
Maximum efficiency	98.2%	98.3%	98.4%	98.6%	98.6%	98.6%	98.6%
European efficiency	96.7%	97.1%	97.5%	97.7%	98.0%	98.1%	98.1%

Input

Technical Specifications	SUN2000-3KTL-M1	SUN2000-4KTL-M1	SUN2000-5KTL-M1	SUN2000-6KTL-M1	SUN2000-8KTL-M1	SUN2000-10KTL-M1	SUN2000-10KTL-BEM1
Maximum input voltage ^a	1100 V						
Maximum input current (per MPPT)	11 A/13.5 A (Subject to the product nameplate)						

Technical Specifications	SUN2000-3KTL-M1	SUN2000-4KTL-M1	SUN2000-5KTL-M1	SUN2000-6KTL-M1	SUN2000-8KTL-M1	SUN2000-10KTL-M1	SUN2000-10KTL-BEM1
Maximum short-circuit current (per MPPT)	15 A/19.5 A (Subject to the product nameplate)						
Minimum startup voltage	200 V						
MPP voltage range	140–980 V						
Full-load MPPT voltage range	140–850 V DC	160–850 V DC	200–850 V DC	235–850 V DC	315–850 V DC	390–850 V DC	390–850 V DC
Rated input voltage	600 V						
Maximum number of inputs	2						
Number of MPPTs	2						
Battery normal voltage	600 Vdc						
Battery voltage range	600-1000 Vdc						
Battery maximum current	16.7 A						
Battery type	Li-ion						
<p>Note a: The maximum input voltage is the maximum DC input voltage that the SUN2000 can withstand. If the input voltage exceeds this value, the SUN2000 may be damaged.</p>							

Output (On Grid)

Technical Specifications	SUN2000-3KTL-M1	SUN2000-4KTL-M1	SUN2000-5KTL-M1	SUN2000-6KTL-M1	SUN2000-8KTL-M1	SUN2000-10KTL-M1	SUN2000-10KTL-BEM1
Rated output power	3000 W	4000 W	5000 W	6000 W	8000 W	10,000 W	10,000 W
Maximum apparent power	3300 VA	4400 VA	5500 VA	6600 VA	8800 VA	11,000 VA	10,000 VA
Maximum active power (cos ϕ = 1)	3300 W	4400 W	5500 W	6600 W	8800 W	11,000 W	10,000 W
Rated output voltage	220 V/380 V, 230 V/400 V, 3W+N+PE						
Maximum output voltage at long-term operation	See standards about the local power grid.						
Rated output current	4.6 A (380 V)/ 4.4 A (400 V)	6.1 A (380 V)/ 5.8 A (400 V)	7.6 A (380 V)/ 7.3 A (400 V)	9.1 A (380 V)/ 8.7 A (400 V)	12.2 A (380 V)/ 11.6 A (400 V)	15.2 A (380 V)/ 14.5 A (400 V)	15.2 A (380 V)/ 14.5 A (400 V)
Maximum output current	5.1 A	6.8 A	8.5 A	10.1 A	13.5 A	16.9 A	16.9 A
Rated apparent power	3 kVA	4 kVA	5 kVA	6 kVA	8 kVA	10 kVA	10 kVA
Inrush current	5.1 A	6.8 A	8.5 A	10.1 A	13.5 A	16.9 A	16.9 A
Max output fault current	15.06 A	20.08 A	25.1 A	30.12 A	40.16 A	50.2 A	50.2 A
Max output overcurrent protection	31.8 A	31.8 A	31.8 A	31.8 A	31.8 A	31.8 A	31.8 A
Output voltage frequency	50 Hz/60 Hz						
Power factor	0.8 leading–0.8 lagging						

Technical Specifications	SUN2000-3KTL-M1	SUN2000-4KTL-M1	SUN2000-5KTL-M1	SUN2000-6KTL-M1	SUN2000-8KTL-M1	SUN2000-10KTL-M1	SUN2000-10KTL-BEM1
Maximum total harmonic distortion (THD) AC THDi	< 3% under rated conditions. Single harmonic meets the VDE4105 requirements.						

Output (Off Grid)

Technical Specifications	SUN2000-3KTL-M1	SUN2000-4KTL-M1	SUN2000-5KTL-M1	SUN2000-6KTL-M1	SUN2000-8KTL-M1	SUN2000-10KTL-M1	SUN2000-10KTL-BEM1
Rated apparent power	3000 VA	3300 VA					
Maximum apparent power	3300 VA	3630 VA					

Protection

Technical Specifications	SUN2000-3KTL-M1	SUN2000-4KTL-M1	SUN2000-5KTL-M1	SUN2000-6KTL-M1	SUN2000-8KTL-M1	SUN2000-10KTL-M1	SUN2000-10KTL-BEM1
Overvoltage category	PV II/AC III						
Input DC switch	Supported						
Islanding protection	Supported						
Output overcurrent protection	Supported						
Input reverse connection protection	Supported						
PV string fault detection	Supported						

Technical Specifications	SUN2000-3KTL-M1	SUN2000-4KTL-M1	SUN2000-5KTL-M1	SUN2000-6KTL-M1	SUN2000-8KTL-M1	SUN2000-10KTL-M1	SUN2000-10KTL-BEM1
DC surge protection	DC common mode: 10 kA						
AC surge protection	Common mode: 5 kA; differential mode: 5 kA						
Insulation resistance detection	Supported						
Residual current monitoring (RCMU)	Supported						
AFCI	Supported						
PV module safe shutdown, optimizer	Supported						
PID repair	Supported						
Active anti-islanding method	AFD						
Protection class	I						
PV and AC port	DVCC						
Communication port	DVCA						

Display and Communication

Technical Specifications	SUN2000-3KTL-M1	SUN2000-4KTL-M1	SUN2000-5KTL-M1	SUN2000-6KTL-M1	SUN2000-8KTL-M1	SUN2000-10KTL-M1	SUN2000-10KTL-BEM1
Display	LED and WLAN+app						
RS485	Supported						

Technical Specifications	SUN2000-3KTL-M1	SUN2000-4KTL-M1	SUN2000-5KTL-M1	SUN2000-6KTL-M1	SUN2000-8KTL-M1	SUN2000-10KTL-M1	SUN2000-10KTL-BEM1
External expansion communication module	Supports WLAN and 4G.						
remote ripple control	Supported						

General Specifications

Technical Specifications	SUN2000-3KTL-M1	SUN2000-4KTL-M1	SUN2000-5KTL-M1	SUN2000-6KTL-M1	SUN2000-8KTL-M1	SUN2000-10KTL-M1	SUN2000-10KTL-BEM1
Dimensions (W x H x D, mm)	525 x 470 x 166 (including only the rear mounting kit of the SUN2000)						
Weight	17 kg (including only the rear mounting kit of the SUN2000)						
Noise	29 dB (A) (typical working condition)						
Operating temperature	-25°C to +60°C (derated when the temperature is higher than 45°C)						
Operating humidity	0-100% RH						
Cooling mode	Natural convection						
Maximum operating altitude	4000 m (derated when the altitude is greater than 3000 m)						
Storage temperature	-40°C to +70°C						
Storage humidity	5-95% RH (non-condensing)						
Input terminal	Staubli MC4						
Output terminal	Waterproof quick-connect terminal						
IP rating	IP65						
Topology	Non-Isolation						

Technical Specifications	SUN2000-3KTL-M1	SUN2000-4KTL-M1	SUN2000-5KTL-M1	SUN2000-6KTL-M1	SUN2000-8KTL-M1	SUN2000-10KTL-M1	SUN2000-10KTL-BEM1
Environmental protection requirements	RoHS 6						

Wireless Communication Parameters

Specifications	Inverter Built-in WiFi	WLAN-FE Smart Dongle	4G Smart Dongle
Frequency	2400–2483.5 MHz	SDongleA-05: 2400–2483.5 MHz	SDongleA-03-EU: <ul style="list-style-type: none"> • Supports LTE-FDD: B1/B3/B7/B8/B20. • Supports LTE-TDD: B38/B40. • Supports WCDMA/HSDPA/HSUPA/HSPA+: B1/B8. • Supports GSM/GPRS/EDGE: 900 MHz/1800 MHz. SDongleB-06-EU (WiFi): 2400–2483.5 MHz SDongleB-06-EU (4G): <ul style="list-style-type: none"> • Supports LTE-FDD: B1/B3/B5/B8. • Supports LTE-TDD: B7/B20/B28/B38/B40/B41. • Supports GSM/GPRS/EDGE: 900 MHz/1800 MHz.

Specifications	Inverter Built-in WiFi	WLAN-FE Smart Dongle	4G Smart Dongle
Protocol standard	WLAN 802.11b/g/n	SDongleA-05: WLAN 802.11b/g/n	SDongleA-03-EU: <ul style="list-style-type: none"> • Supports LTE-FDD (with receive diversity): B1/B3/B7/B8/B20/B28. • Supports LTE-FDD (with receive diversity): B38/B40/B41. • Supports WCDMA: B1/B8. • Supports GSM: 900 MHz/1800 MHz. • Supports digital audio. SDongleB-06-EU (WiFi): WLAN 802.11b/g/n SDongleB-06-EU (4G): <ul style="list-style-type: none"> • Supports LTE FDD (with receive diversity): B1/B3/B5/B8. • Supports LTE-TDD (with receive diversity): B7/B20/B28/B38/B40/B41. • Supports GSM: 900 MHz/1800 MHz. • Supports digital audio.

Specifications	Inverter Built-in WiFi	WLAN-FE Smart Dongle	4G Smart Dongle
Bandwidth	20 MHz/40 MHz (optional)	20 MHz/40 MHz (optional)	<p>LTE features:</p> <ul style="list-style-type: none"> • Supports a maximum of 3GPP R8 non-CA Cat 4 FDD and TDD. • Supports 1.4 MHz/3 MHz/5 MHz/10 MHz/15 MHz/20 MHz RF bandwidth. • Supports MIMO in the downlink. • LTE-FDD: maximum downlink rate of 150 Mbit/s and maximum uplink rate of 50 Mbit/s • LTE-TDD: maximum downlink rate of 130 Mbit/s and maximum uplink rate of 30 Mbit/s <p>UMTS features:</p> <ul style="list-style-type: none"> • Supports 3GPP R7 HSDPA+, HSDPA, HSUPA, and WCDMA. • Supports QPSK and 16QAM modulation. • HSDPA+: maximum downlink rate of 21 Mbit/s • HSUPA: maximum uplink rate of 5.76 Mbit/s • WCDMA: maximum downlink rate of 384 kbit/s and maximum uplink rate of 384 kbit/s <p>GSM features:</p> <p>GPRS:</p> <ul style="list-style-type: none"> • Supports GPRS multislots class 12. • Coding schemes: CS-1, CS-2, CS-3, and CS-4 • Maximum downlink rate: 85.6 kbit/s; maximum uplink rate: 85.6 kbit/s <p>EDGE:</p> <ul style="list-style-type: none"> • Supports EDGE multislots class 12.

Specifications	Inverter Built-in WiFi	WLAN-FE Smart Dongle	4G Smart Dongle
			<ul style="list-style-type: none"> • Supports GMSK and 8-PSK modulation and coding schemes. • Downlink coding format: MCS 1–9 • Uplink coding format: MCS 1–9 • Maximum downlink rate: 236.8 kbit/s; maximum uplink rate: 236.8 kbit/s SDongleB-06-EU (WiFi): 20 MHz/40 MHz (optional)
Maximum transmit power	≤ 20 dBm EIRP	≤ 20 dBm EIRP	<ul style="list-style-type: none"> • Class 4 (33 dBm±2 dB), EGSM900 frequency band • Class 1 (30 dBm±2 dB), DCS1800 frequency band • Class E2 (27 dBm±3 dB), EGSM900 8-PSK • Class E2 (26 dBm±3 dB), DCS1800 8-PSK • Class 3 (24 dBm+1/–3 dB), WCDMA frequency band • Class 3 (23 dBm±2 dB), LTE-FDD frequency band • Class 3 (23 dBm±2 dB), LTE-TDD frequency band SDongleB-06-EU (WiFi): ≤ 20 dBm EIRP

10.2 Optimizer Technical Specifications

Efficiency

Technical Specifications	SUN2000-450W-P
Maximum efficiency	99.5%
European weighted efficiency	99.0%

Input

Technical Specifications	SUN2000-450W-P
Rated PV module power	450 W
Maximum PV module power	472.5 W
Maximum input voltage	80 V
MPPT voltage range	8–80 V
Maximum short-circuit current	13 A
Overtoltage level	II

Output

Technical Specifications	SUN2000-450W-P
Rated output power	450 W
Output voltage	4–80 V
Maximum output current	15 A
Output bypass	Yes
Shutdown output voltage/impedance	0 V/1 k Ω ($\pm 10\%$)

Common Parameters

Technical Specifications	SUN2000-450W-P
Dimensions (W x H x D)	71 mm x 138 mm x 25 mm
Net weight	≤ 550 g
DC input and output terminals	Staubli MC4

Technical Specifications	SUN2000-450W-P
Operating temperature	-40°C to +85°C
Storage temperature	-40°C to +70°C
Operating humidity	0–100% RH
Maximum operating altitude	4000 m
IP rating	IP68
Installation mode	<ul style="list-style-type: none">• PV module support installation• PV module frame installation

Long String Design (Full Optimizer Configuration)

Technical Specifications	SUN2000-3KTL-M1	SUN2000-4KTL-M1	SUN2000-5KTL-M1	SUN2000-6KTL-M1	SUN2000-8KTL-M1	SUN2000-10KTL-M1	SUN2000-10KTL-BEM1
Minimum optimizer number per string	6						
Maximum optimizer number per string	35						
Maximum DC power per string	10,000 W						

A Grid Code

 **NOTE**

- The grid codes are subject to change. The listed codes are for reference only.
- The SUN2000-10KTL-BEM1 supports only the Belgium grid code.

Table A-1 Grid Code

No.	Grid Code	Remarks
1	VDE-AR-N-4105	Germany low-voltage (LV) power grid
2	UTE C 15-712-1(A)	France mainland power grid
3	UTE C 15-712-1(B)	France island power grid
4	UTE C 15-712-1(C)	France island power grid
5	EN50438-CZ	Czech power grid
6	RD1699/661	Spain LV power grid
7	EN50438-NL	Netherlands power grid
8	C10/11	Belgium power grid
9	IEC61727	IEC 61727 LV grid-tied power grid (50 Hz)
10	Custom (50 Hz)	Reserved
11	Custom (60 Hz)	Reserved
12	TAI-PEA	Thailand grid-tied standard power grid
13	TAI-MEA	Thailand grid-tied standard power grid
14	EN50438-TR	Turkey LV power grid code

No.	Grid Code	Remarks
15	IEC61727-60Hz	IEC61727 low-voltage power grid (60 Hz)
16	EN50438_IE	Ireland LV power grid
17	PO12.3	Spain LV power grid
18	EN50549-LV	Ireland power grid
19	ABNT NBR 16149	Brazil power grid
20	DUBAI	Dubai LV power grid
21	TAIPOWER	Taiwan Power LV power grid
22	EN50438-SE	Sweden LV power grid
23	Austria	Austria power grid
24	G98	UK G98 power grid
25	G99-TYPEA-LV	UK G99_TypeA_LV power grid
26	SINGAPORE	Singapore LV power grid
27	HONGKONG	Hong Kong LV power grid
28	EN50549-SE	Sweden LV power grid
29	AUSTRALIA-AS4777_A-LV230	Australia power grid
30	AUSTRALIA-AS4777_B-LV230	Australia power grid
31	AUSTRALIA-AS4777_C-LV230	Australia power grid
32	AUSTRALIA-AS4777_NZ-LV230	Australia power grid
33	EN50549-PL	Poland
34	CEI0-21	Italy LV power grid
35	SWITZERLAND-NA/EEA:2020-LV230	Switzerland
36	DENMARK-EN50549-DK1-LV230	Denmark power grid
37	DENMARK-EN50549-DK2-LV230	Denmark power grid
38	Pakistan	Pakistan
39	OMAN	Oman low-voltage power grid
40	CZECH-EN50549-LV230	Czech power grid
41	FINLAND-EN50549-LV230	Finland power grid
42	ANRE	Romania low-voltage power grid
43	Israel	Israel power grid

No.	Grid Code	Remarks
44	Philippines	Philippines low-voltage power grid
45	NEW CALEDONIA-LV230	New Caledonia power grid

B Device Commissioning

Step 1 Access **Device Commissioning** screen.

Figure B-1 Method 1: before login (not connected to the Internet)



Figure B-2 Method 2: after login (connected to the Internet)



Step 2 Connect to the solar inverter WLAN and log in to the device commissioning screen as the **installer** user.

NOTICE

- When connecting to the SUN2000 directly from the mobile phone, keep the mobile phone visible within 3 meters of the SUN2000 to ensure the communication quality between the app and SUN2000. The distances are for reference only and may vary with mobile phones and shielding conditions.
- When connecting the SUN2000 to the WLAN over a router, ensure that the mobile phone and SUN2000 are in the WLAN coverage of the router and the SUN2000 is connected to the router.
- The router supports WLAN (IEEE 802.11 b/g/n, 2.4 GHz) and the WLAN signal reaches the SUN2000.
- The WPA, WPA2, or WPA/WPA2 encryption mode is recommended for routers. Enterprise-level encryption is not supported (for example, public hotspots requiring authentication such as airport WLAN). WEP and WPA TKIP are not recommended because these two encryption modes have serious security defects. If the access fails in WEP mode, log in to the router and change the encryption mode of the router to WPA2 or WPA/WPA2.

Figure B-3 Quick settings

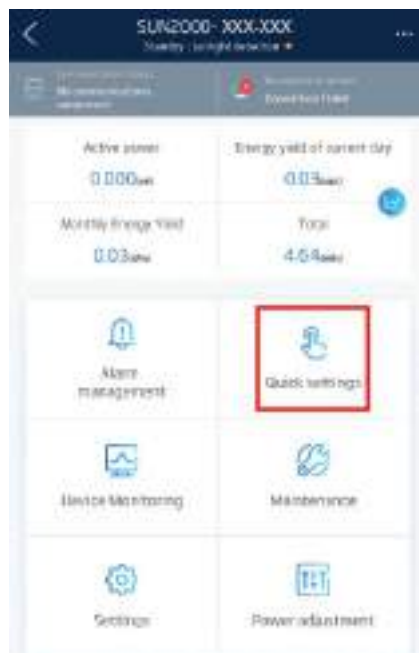



 **NOTE**

- Obtain the initial password for connecting to the solar inverter WLAN from the label on the side of the solar inverter.
- Use the initial password upon first power-on and change it immediately after login. To ensure account security, change the password periodically and keep the new password in mind. Not changing the initial password may cause password disclosure. A password left unchanged for a long period of time may be stolen or cracked. If a password is lost, devices cannot be accessed. In these cases, the user is liable for any loss caused to the PV plant.
- When you access the **Device Commissioning** screen of the SUN2000 for the first time, you need to manually set the login password because the SUN2000 does not have an initial login password.

----End

C Resetting Password

Step 1 Check that the AC and DC sides of the inverter are both powered on, and indicators  and  are steady green or blinking slowly for more than 3 minutes.

Step 2 Complete the following operations within 4 minutes:

Turn off the AC switch and set **DC SWITCH** to **OFF** at the bottom of the inverter. If the inverter is connected to a battery, turn off the battery switch. Wait until all LED indicators on the inverter panel turn off.

Turn on the AC switch and set **DC SWITCH** to **ON**. Wait about 90s and check that indicator  is blinking green slowly.

Turn off the AC switch and set **DC SWITCH** to **OFF**. Wait until all LED indicators on the inverter panel turn off.

Turn on the AC switch and set **DC SWITCH** to **ON**. Wait until all LED indicators on the inverter panel blink and then turn off after 30s.

Step 3 Reset the password within 10 minutes. (If no operation is performed within 10 minutes, all parameters of the inverter remain unchanged.)

1. Wait until indicator  blinks green slowly.
2. Connect to the app using the initial WLAN hotspot name (SSID) and initial password (PSW), which can be obtained from the label on the side of the inverter.
3. On the login screen, set a new password and log in to the app.

Figure C-1 Setting the password



Step 4 Set router and management system parameters to implement remote management.

- Setting router parameters

Log in to the FusionSolar app, choose **Device Commissioning** > **Settings** > **Communication configuration** > **Router connection settings**, and set router parameters.

Figure C-2 Setting router parameters



- Setting management system parameters

Log in to the FusionSolar app, choose **Device Commissioning** > **Settings** > **Communication configuration** > **Management System Configuration**, and set management system parameters.

Figure C-3 Setting management system parameters



- (Optional) Resetting the WLAN password
Log in to the FusionSolar app, choose **Device Commissioning** > **Settings** > **Communication configuration** > **Inverter WLAN settings**, and reset the WLAN password.

Figure C-4 Resetting the WLAN password

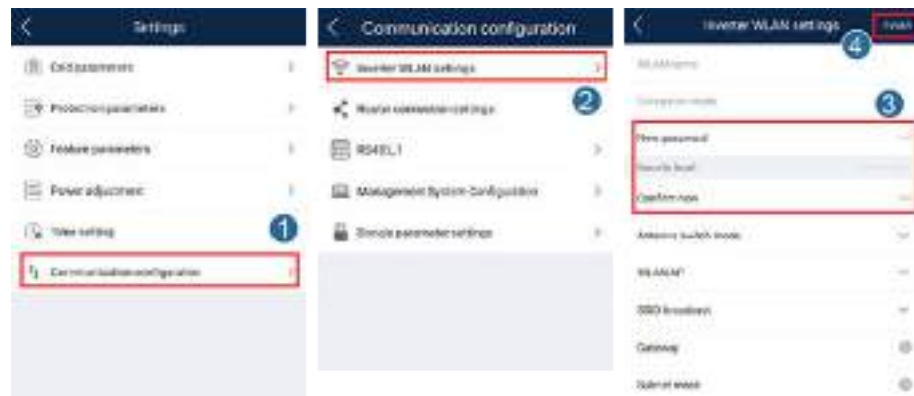

----End

D Rapid Shutdown

NOTE

The rapid shutdown function is supported only if optimizers are configured for all PV modules.

When all PV modules connected to the solar inverter are configured with optimizers, the PV system shuts down quickly and reduces the output voltage of the PV string to below 30 V within 30 seconds.

Perform the following step to trigger rapid shutdown:

- Method 1: To enable the rapid shutdown function, you need to connect the access switch to pins 13 and 15 of the SUN2000 communications terminal. The switch is closed by default. The rapid shutdown is triggered when the switch changes from closed to open.
- Method 2: Turn off the AC switch between the solar inverter and the power grid. (If the inverter supports the off-grid function and **Off-grid mode** is enabled by choosing **Settings > Feature parameters** on the home screen, turning off the AC switch will not trigger a rapid shutdown.)
- Method 3: Set the DC switch at the bottom of the SUN2000 to OFF. (Turning off an extra switch on the DC side of the SUN2000 will not trigger rapid shutdown. The PV string may be energized.)
- Method 4: If **AFCI** is enabled, the inverter automatically detects arc faults, triggering a rapid shutdown.

E AI Energy Management Assistant (EMMA)

The AI Energy Management Assistant (EMMA) provides intelligent energy scheduling and management functions. Based on big data analysis, it accurately predicts the power generation and consumption curves of households, and intelligently stores, purchases, and sells electricity to achieve optimal system performance, improve the utilization rate of green power, and maximize financial benefits.

- Method 1: FusionSolar Smart PV Management System WebUI

When the system determines that the plant meets the conditions for enabling the EMMA function, the **EMMA** dialog box is displayed. You can enable the EMMA function as prompted. If you select **Not Now**, you can click



next to **EMMA** and enable the EMMA function as prompted.

- Method 2: FusionSolar app

On the **Overview** screen, if the system determines that the plant meets the



conditions for enabling the EMMA function,  is displayed in the energy flow diagram. You can tap this icon to enable the EMMA function. Alternatively, tap ... in the upper right corner and then tap **EMMA**.

NOTE

- Only owners have the permission to enable the EMMA function. After the EMMA function is enabled, owners and installers can view the relevant revenue and energy forecast and analysis.
- For details, see the user manuals of the FusionSolar Smart PV Management System and FusionSolar app.

F Acronyms and Abbreviations

L	
LED	light emitting diode
M	
MPP	maximum power point
MPPT	maximum power point tracking
P	
PV	photovoltaic